

NFC Programmable 2-Key Push to DALI Control Unit



Important: Read All Instructions Prior to Installation

Function introduction

2 Channels Push Switch Input/Dry Contact Motion Sensor Input

K1 (White): first key/motion sensor input

K2 (Pink): second key/motion sensor input

NFC position: touch the NFC position with NFC reception area of your smart phone to write the settings to the device

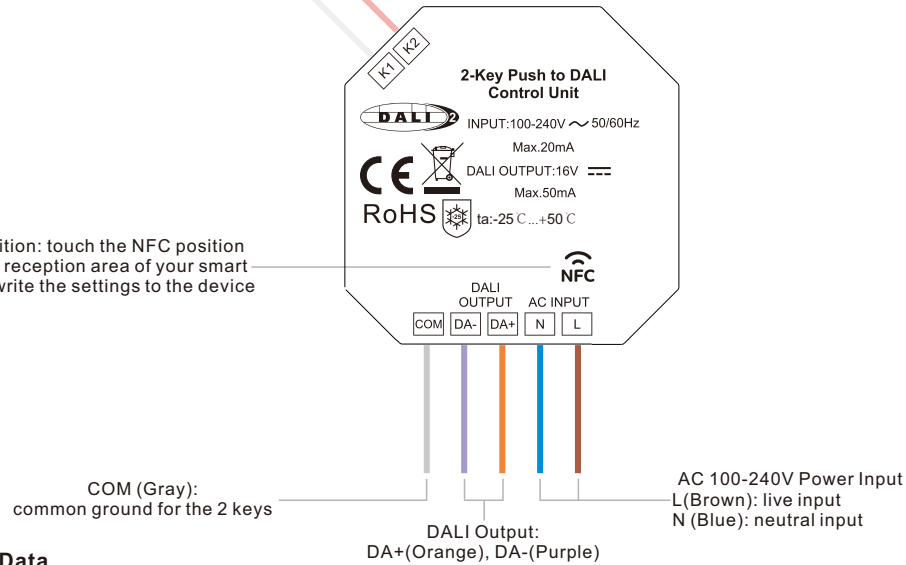

Product Data

Input Signal	2 channels push switch/dry contact motion sensor
Power Supply	100-240VAC(active)/DALI bus(passive)
Output	DALI signal
Output Current	50mA
DALI Current Consumption	<4mA
Controlled DALI Device Type	DT6, DT8 Tc, DT8 XY, DT8 RGBWAF NFC configurable
Operation Mode	Push Dim or Corridor Dim NFC configurable
Push Switch Function	NFC configurable
Motion Sensor Parameters	NFC configurable
Operating Temperature	-20°C-50°C
Relative Humidity	8% to 80%
Dimensions(LxWxH)	45.5x45x20.3mm

Product Features

- NFC programmable 2-key push to DALI control unit
- 2 channels push switch input or dry contact motion sensor input
- PD (Push Dim) mode with push switch input or CD (Corridor Dim) mode with dry contact motion sensor input
- PD mode or CD mode can be set through NFC
- Can work as standalone DALI sensors when connecting with dry contact motion sensors and set as CD mode
- 100-240VAC power supply (active mode) or DALI bus powered (passive mode)
- Built-in 50mA DALI bus power supply to control up to 25 DALI DT6/DT8 control gears
- Up to 100 DALI control gears can be controlled while 4 control units connected to AC mains
- DALI current consumption less than 4mA
- Controlled DALI device type can be freely configured through NFC App
- Supported device types: DT6, Tc, XY coordinates, RGBWAF
- Controlled object of each push switch can be freely configured through NFC App
- Supports broadcast, single address, and group control
- Each push switch supports three different operations: short press, long press, double click
- DALI command triggered by the a push switch operation can be freely configured through NFC App
- Each DALI line can install multiple control units for multi control points
- Waterproof grade: IP20

Safety & Warnings

- DO NOT install with power applied to device.
- DO NOT expose the device to moisture.

Wiring Diagram

PD Mode Push Switch Wiring (Works with 2-gang switch and 1-gang switch)

Connection with 2-gang switch

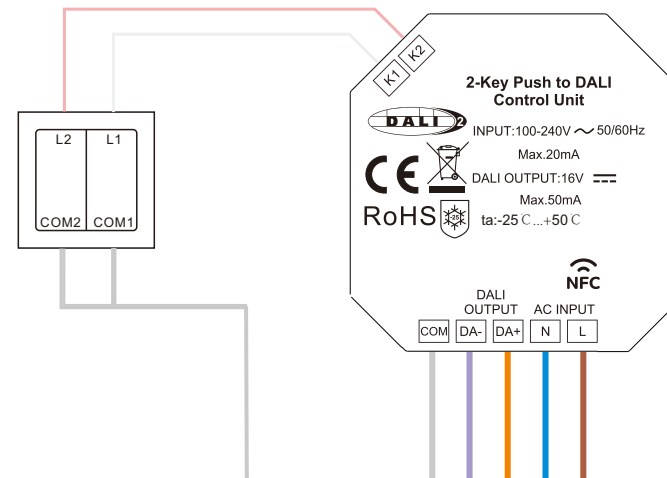

Connection with 1-gang switch

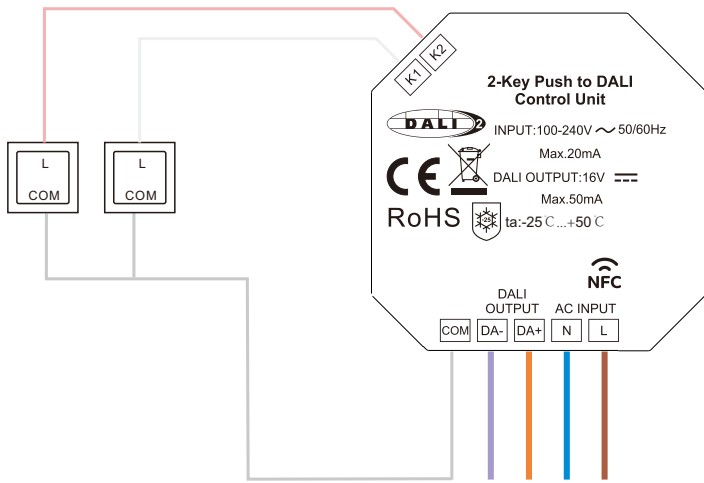

Figure 1: Wiring scheme to control up to 25 DALI ECGs (only 1 control unit powered by AC mains, the other powered by DALI bus)

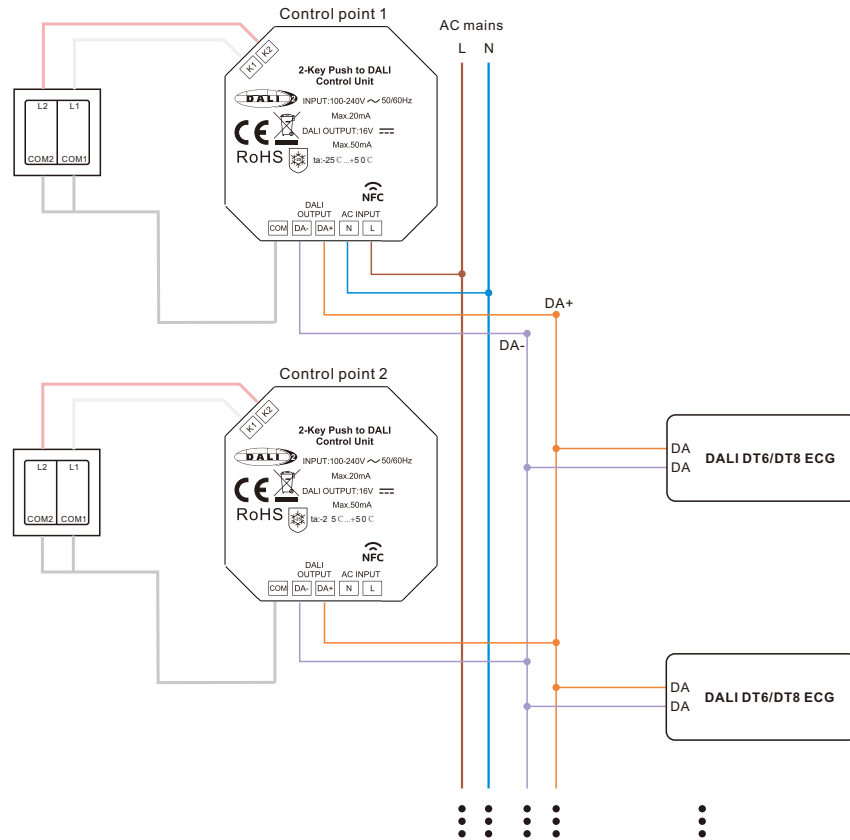

Figure 2: Wiring scheme to control up to 50 DALI ECGs (2 control units powered by AC mains, the other 2 powered by DALI bus)

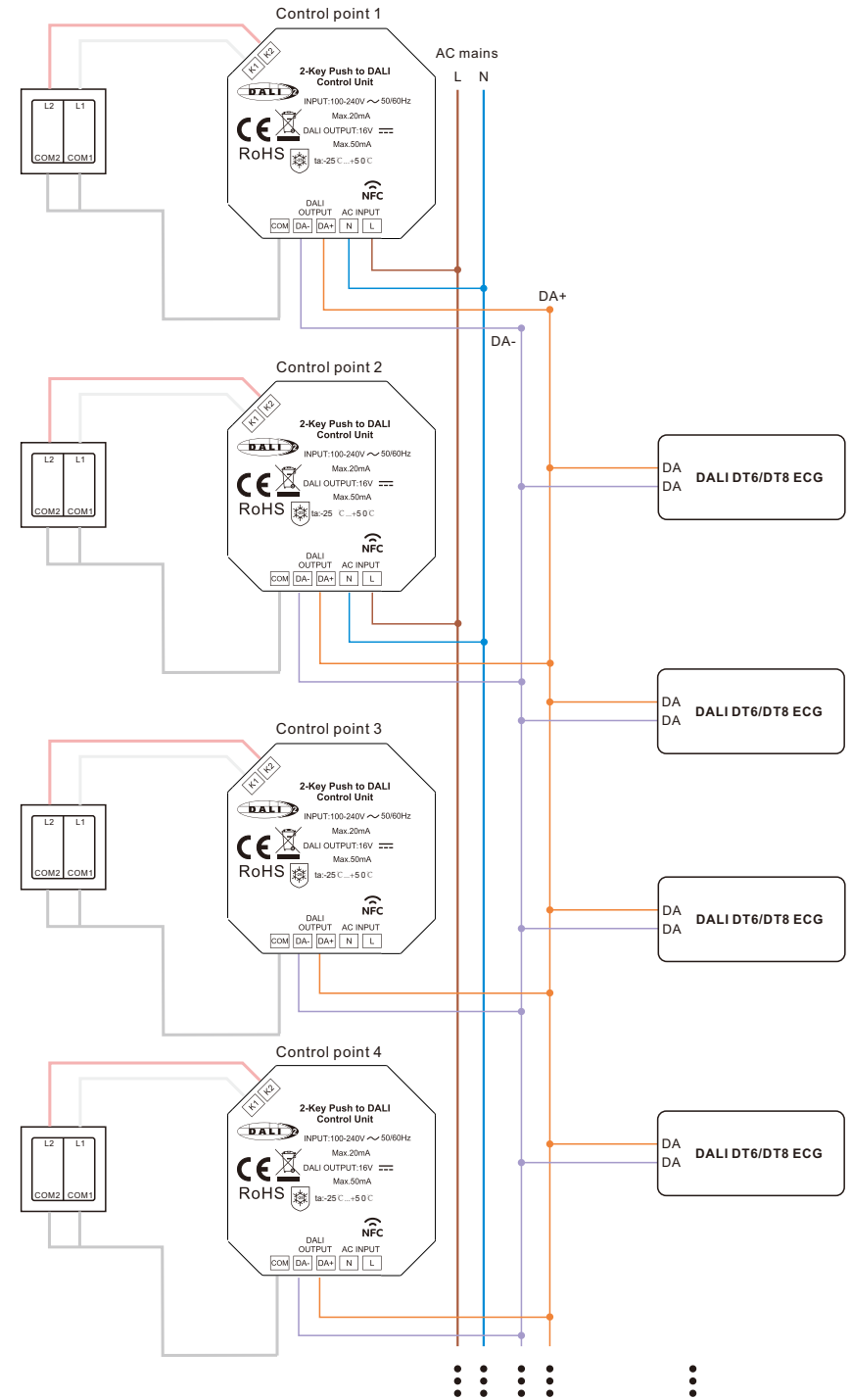

Figure 3: Wiring scheme to control up to 75 DALI ECGs (3 control units powered by AC mains, the other 1 powered by DALI bus)

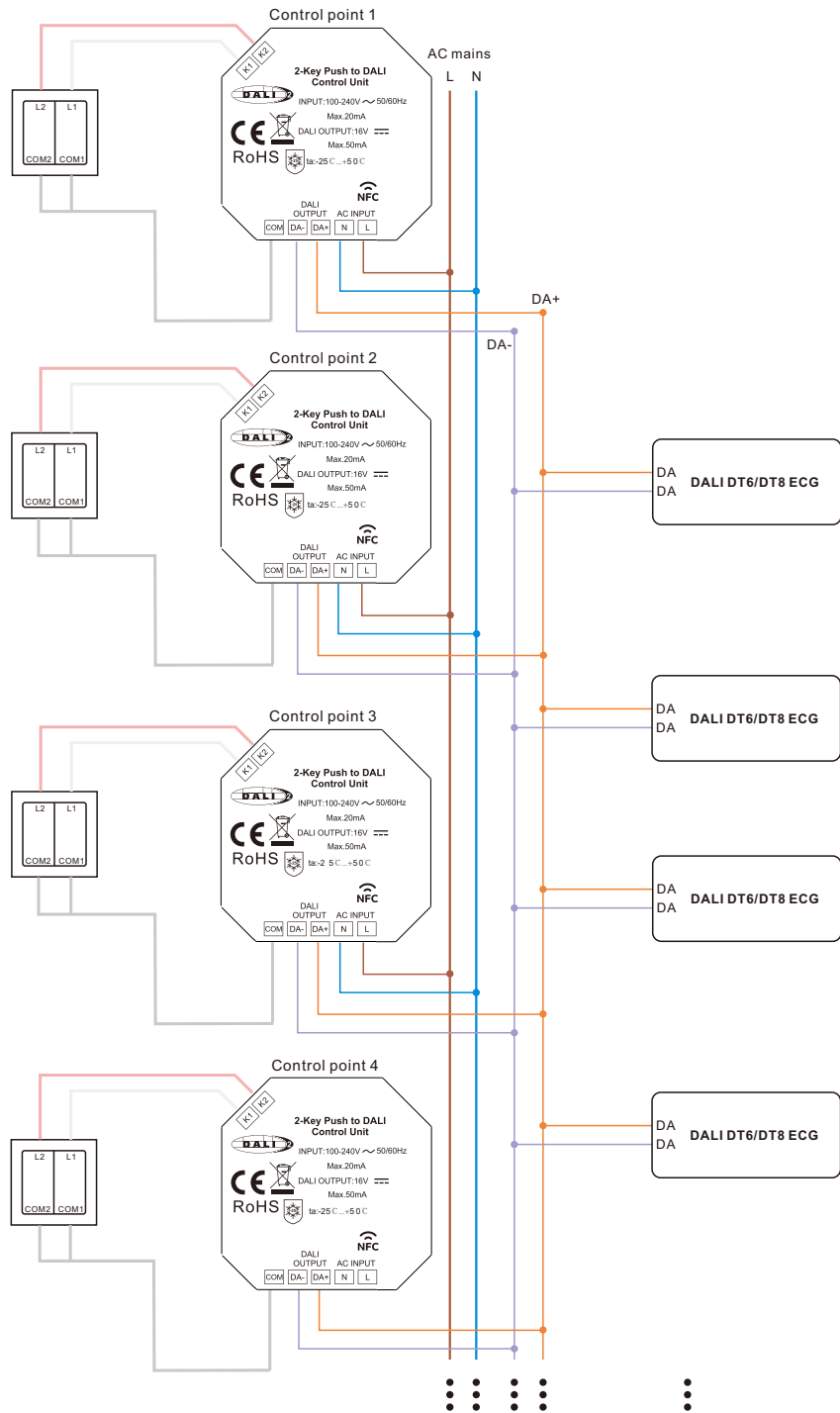
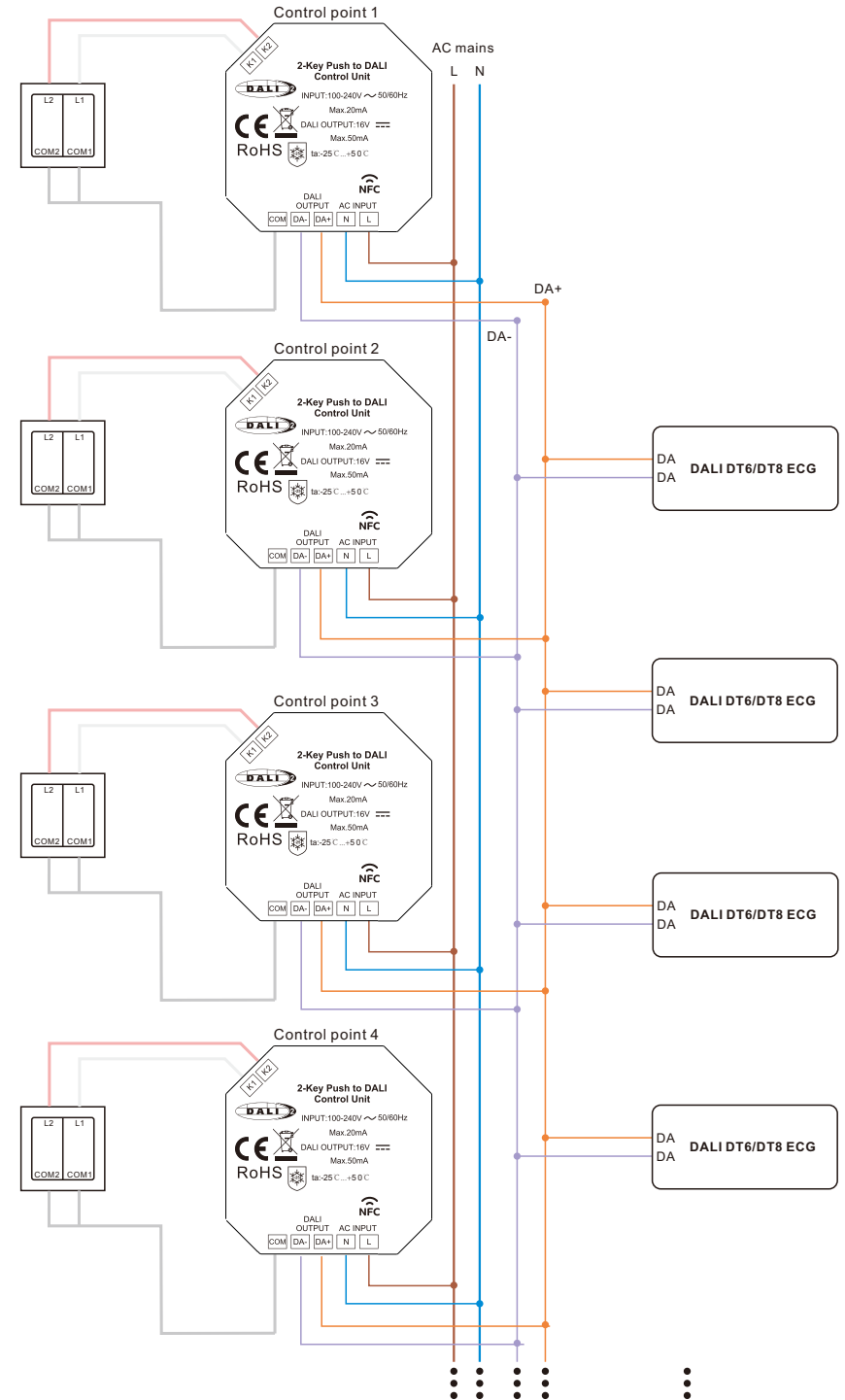

Figure 4: Wiring scheme to control up to 100 DALI ECGs (all 4 control units powered by AC mains)



CD Mode Motion Sensor Wiring

Figure 1: Wiring scheme to control up to 25 DALI ECGs (only 1 control unit powered by AC mains, the other powered by DALI bus)

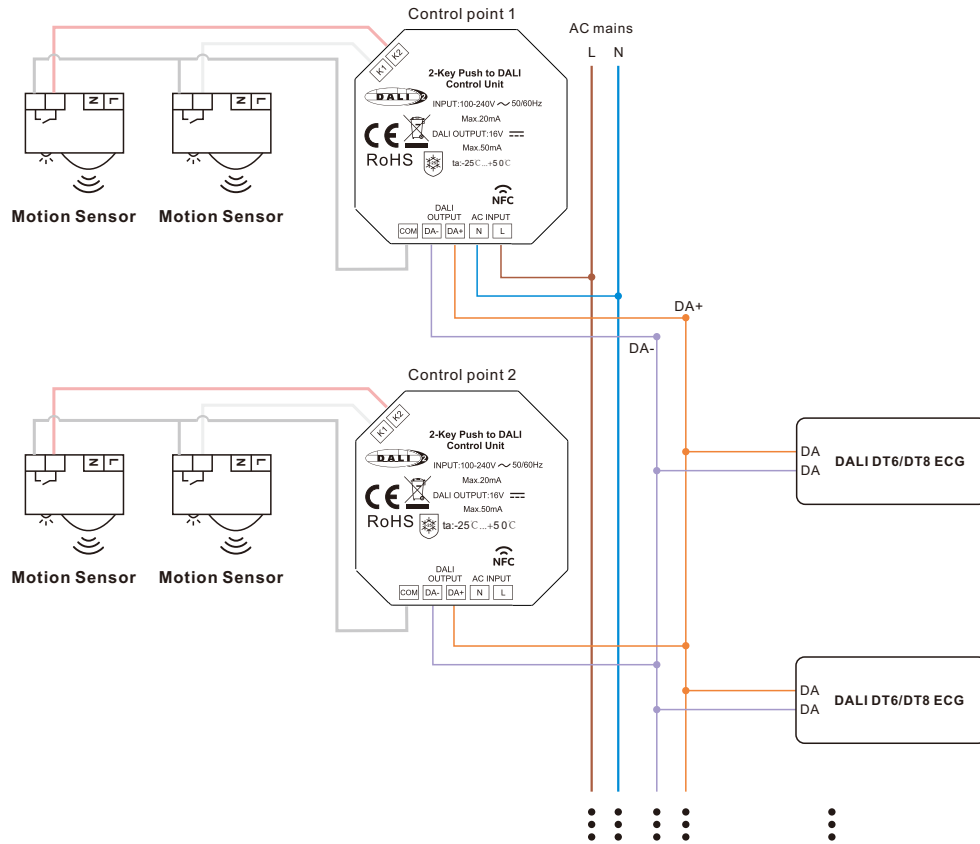

Figure 2: Wiring scheme to control up to 50 DALI ECGs (2 control units powered by AC mains, the other 2 powered by DALI bus)

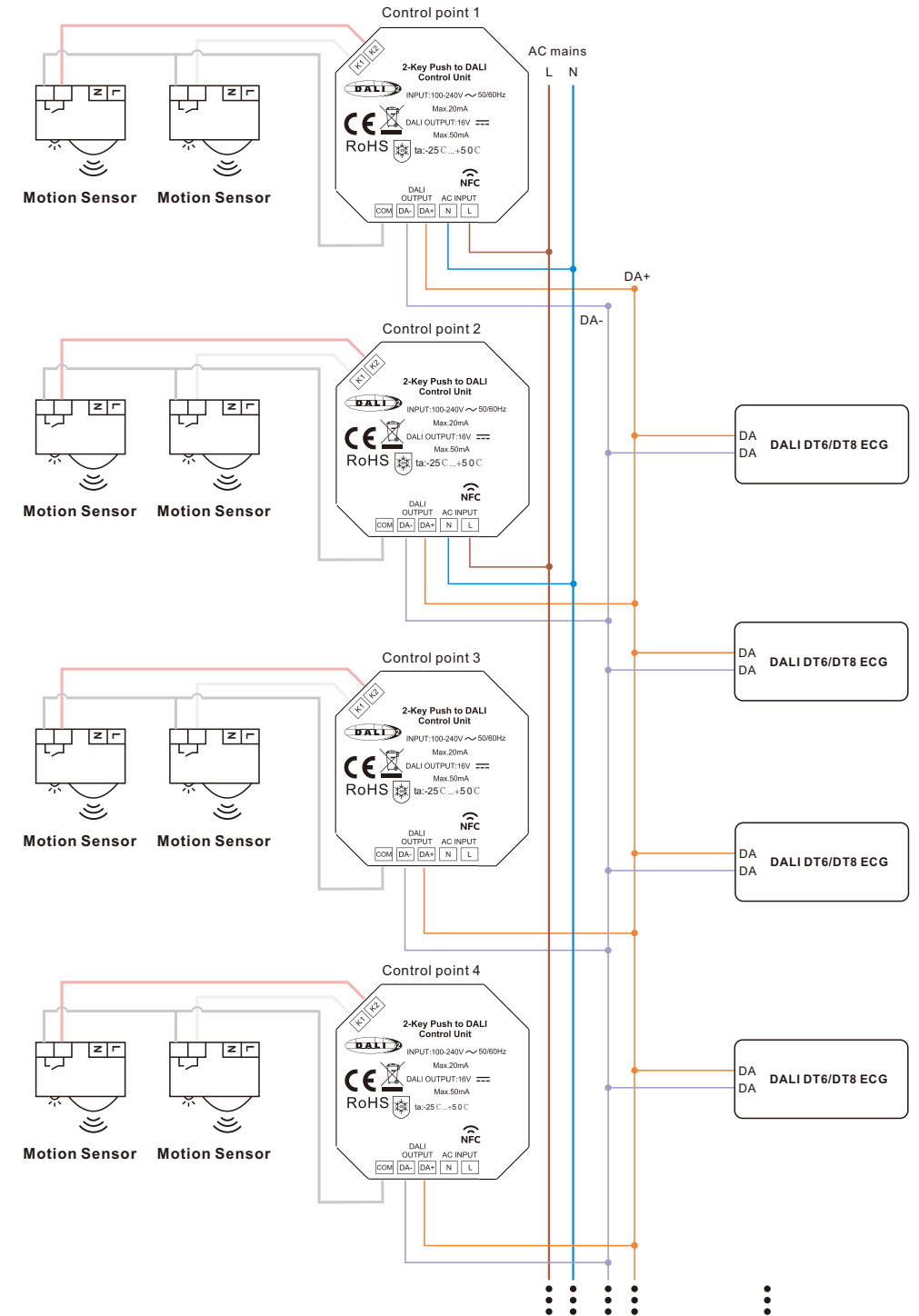

Figure 3: Wiring scheme to control up to 75 DALI ECGs (3 control units powered by AC mains, the other 1 powered by DALI bus)

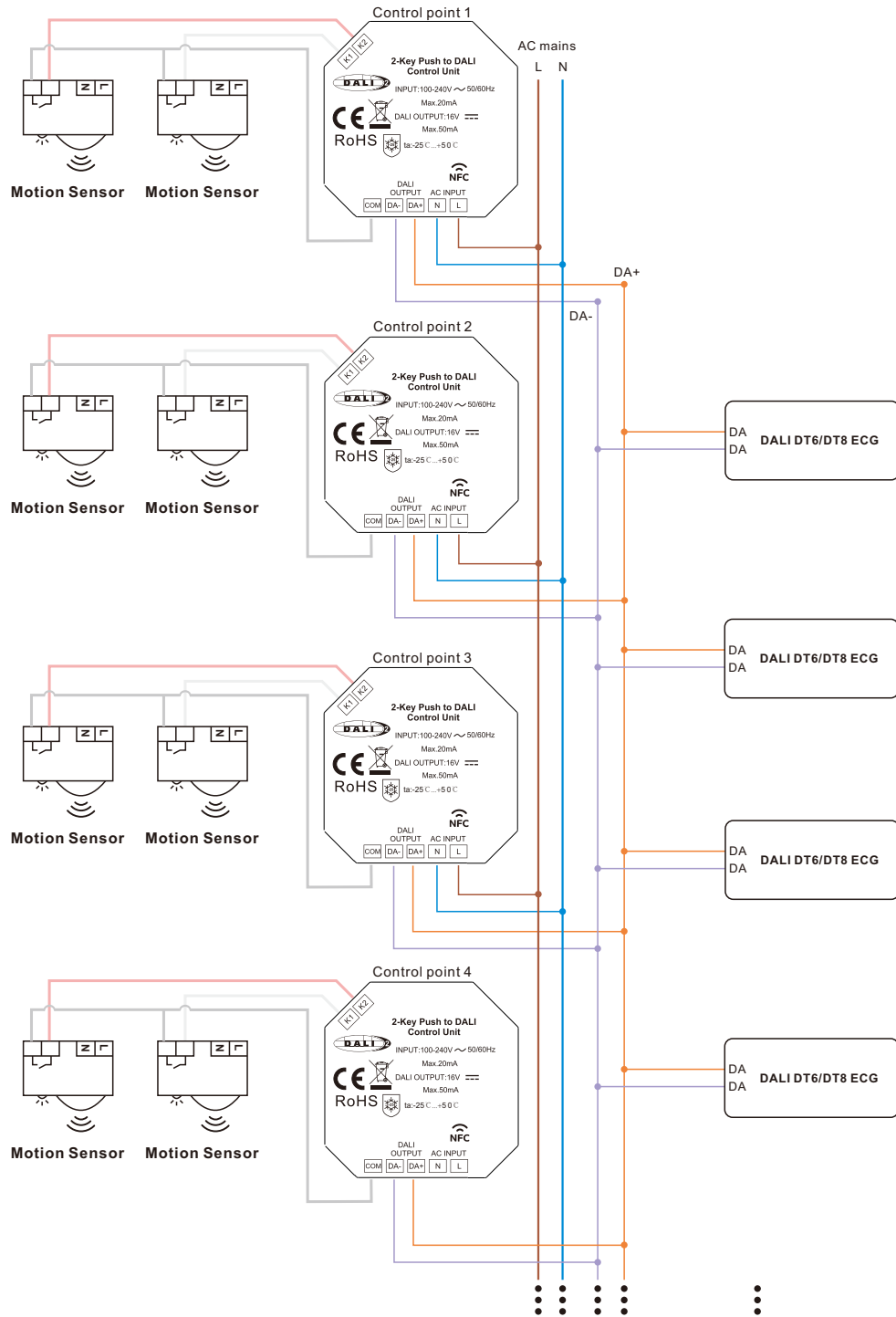
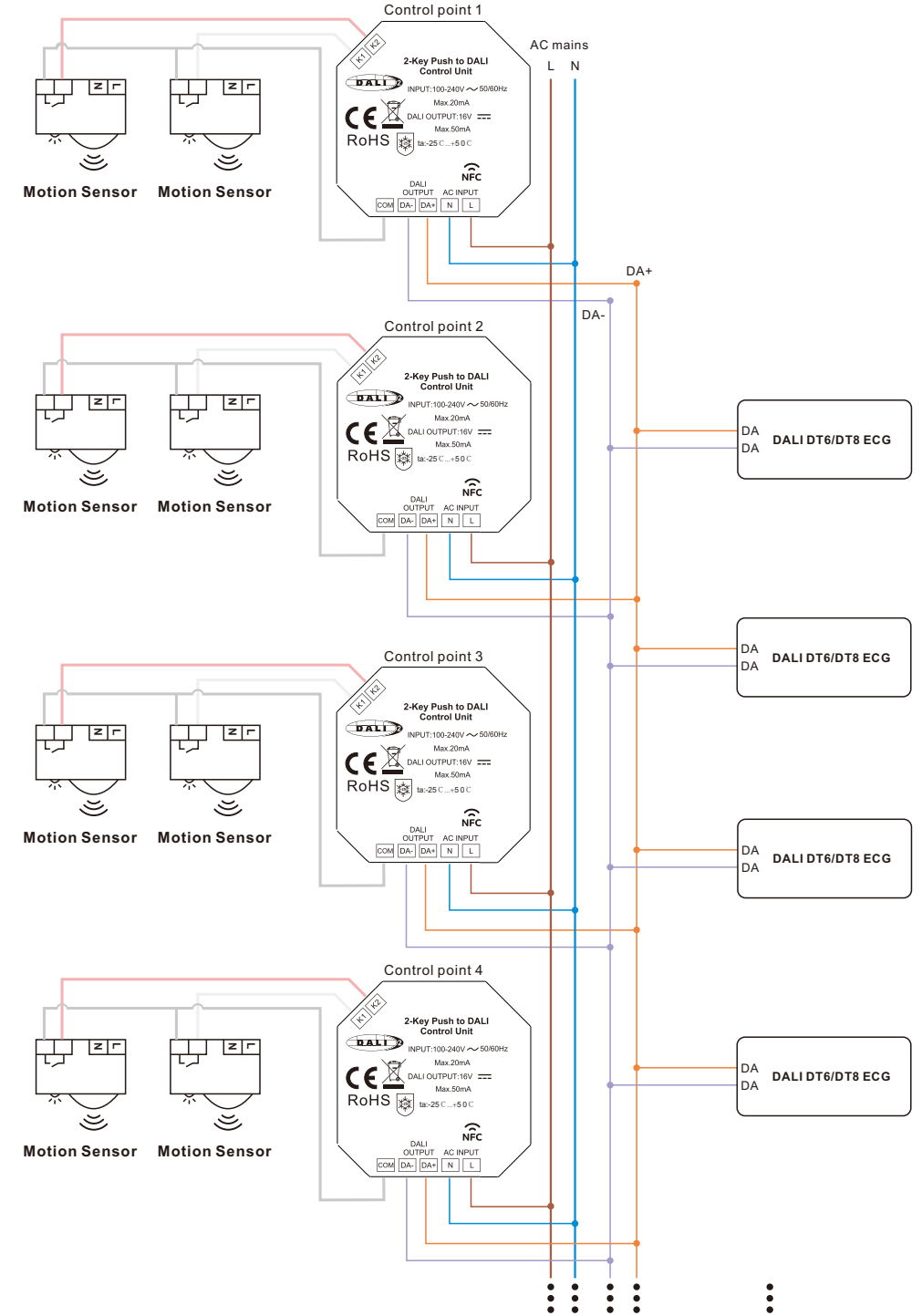

Figure 4: Wiring scheme to control up to 100 DALI ECGs (all 4 control units powered by AC mains)



Programming

Note: During the whole programming process, make sure the control units are disconnected from AC mains and DALI bus.

1. Download NFC App

Step 1: Download and install NFC Programming App to your smart phone or tablet by scanning the following QR codes:



iOS App QR Code



Android App QR Code

Note: Please make sure that your smart phone or tablet supports NFC function.

2. Add Configuration

Step 1: Run the installed app SR NFC Tool as shown in Figure 1. Tap on "+" button at upper right corner to add a configuration as shown in Figure 2, there are two options: "Copy from a device", "Create a default configuration".

"Copy from a device" means to import a configuration from an existing control unit, tap on "Copy from a device", then touch the NFC position of the already programmed control unit with your smart phone or tablet NFC reception area, there should be indication on the app once the configuration is read and imported successfully.

"Create a default configuration" means to select a default configuration from the app, tap on "Create a default configuration", then name the configuration and select "Push-DALI 2KEY" configuration from the list, then tap on "Save" button at upper right corner as shown in Figure 3. The created configuration "SR-2400PD" will be listed under configuration page as shown in Figure 4.



Figure 1



Figure 2

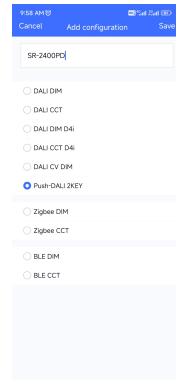

Figure 3

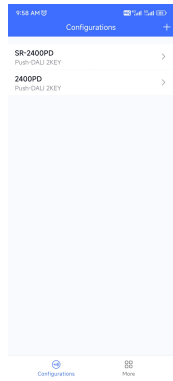

Figure 4

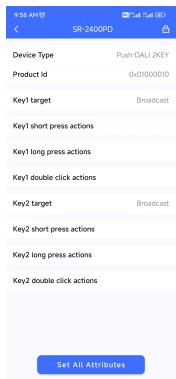

Figure 5

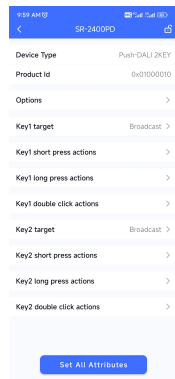

Figure 6

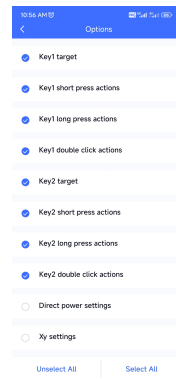

Figure 7

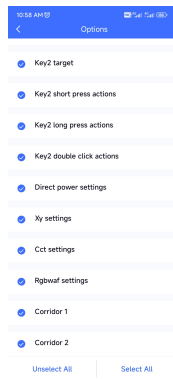

Figure 8

Step 2: Tap the copied or created configuration for instance "SR-2400PD" as shown in Figure 4 to enter programming interface. Tap on "🔒" button at upper right corner to unlock the setting as shown in Figure 5 and Figure 6. We can set the attributes as shown in Figure 6.

3. Enable Options and Set Parameters of PD Mode

Step 1: "Options" setting: tap "Options" as shown in Figure 6, we can select the options we would like to set as shown in Figure 7 and Figure 8.

"target" is to set controlled target of a key.

"short press actions" is to set the DALI command triggered by short press of a key.

"long press actions" is to set the DALI command triggered by long press of a key.

"double click actions" is to set the DALI command triggered by double click of a key.

"Direct power settings" is to set direct brightness values that can be triggered by a key, only when this option is selected, and values of "Direct power settings" are set, a key can trigger a Direct ARC power value. (it's not selected by factory default)

"Xy settings" is to set XY coordinate values that can be triggered by a key, only when this option is selected, and values of "Xy settings" are set, a key can trigger XY coordinate value. (it's not selected by factory default)

"Cct settings" is to set color temperature values that can be triggered by a key, only when this option is selected, and values of "Cct settings" are set, a key can trigger a color temperature value. (it's not selected by factory default)

"Rgbwaf settings" is to set a color by setting the values of RGBWAF channels separately, and the color can be triggered by a key, only when this option is selected, and values of "Rgbwaf settings" are set, a key can trigger a RGBWAF color value. (it's not selected by factory default)

"Corridor 1" is the option that enables users to set the operation mode of K1 input of the control unit as CD mode or PD mode. Once this option is selected, users can select the operation mode of the K1 input: CD (Corridor Dim) mode or PD (Push Dim) mode. If this option is not selected, the operation mode of K1 input of the control unit can only be PD mode. (it's not selected by factory default)

"Corridor 2" is the option that enables users to set the operation mode of K2 input of the control unit as CD mode or PD mode. Once this option is selected, users can select the operation mode of the K2 input: CD (Corridor Dim) mode or PD (Push Dim) mode. If this option is not selected, the operation mode of K2 input of the control unit can only be PD mode. (it's not selected by factory default)

Once "Options" are selected, the configuration interface will list all options that can be set as shown in Figure 9 and Figure 10.

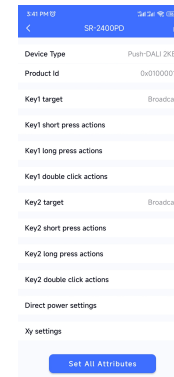

Figure 9

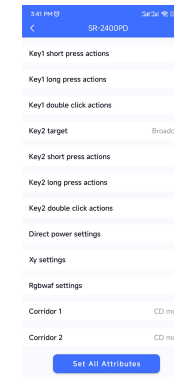

Figure 10

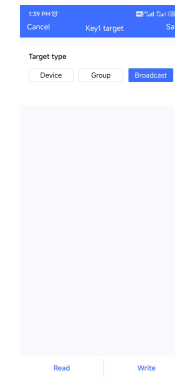

Figure 11

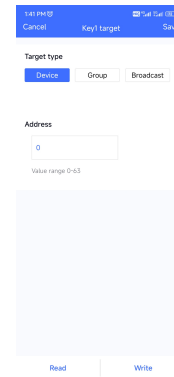

Figure 12

Step 2: "Key1 target" setting: tap "Key1 target" as shown in Figure 9, we can set controlled target of key 1 as shown in Figure 11, Figure 12 and Figure 13. There are three options: "Broadcast" (factory default), "Device" (single DALI control gear), "Group" (a DALI group)". "Save" button at upper right corner means save the setting to smart phone, "Read" button at the bottom means read and import this single attribute from an existing control unit though NFC if you do not want to configure by yourself, "Write" button at the bottom means write this single attribute to a control unit though NFC.

"Broadcast" is to control all DALI ECGs on the DALI line through broadcast.

"Device" is to control a single DALI ECG on the DALI line, you can select an ECG address from 0-63 that you want to control, then tap on "Save" button at upper right corner to save the setting as shown in Figure 12.

"Group" is to control a group of DALI ECGs on the DALI line, you can select an ECG group address from 0-15 that you want to control, then tap on "Save" button at upper right corner to save the setting as shown in Figure 13.

Step 3: "Key1 short press actions" setting: tap "Key1 short press actions" as shown in Figure 9, we can set the DALI commands triggered by short press of key 1 as shown in Figure 14. Up to 10 actions can be set, which means you can set up to 10 actions (Action 1 to Action 10) triggered by 10 times short press in sequence as a cycle, 1st short press triggers Action 1, 2nd short press triggers Action 2, 10th short press triggers Action 10, 11th short press triggers Action 1, 12th short press triggers Action 2, 20th short press triggers Action 10, By factory default, only 2 actions are set, other actions are not set, that means only Action 1 and Action 2 triggered by 2 times short press in sequence as a cycle. Available settings are as follows:

"Direct arc power control 1-16" is to trigger a direct brightness level as shown in **Figure 15**. These actions only work when "Direct power settings" option values are set.

"Off" means turn off, "Up" means smooth dim up, "Down" means smooth dim down, "Step up" means step dim up, "Step down" means step dim down, "Recall max" means recall max level, "Recall min" means recall min level, "Step down and off" means step dim down and off, "On and step up" means turn on and step dim up, "Go to last level" means go to last active level before turn off as shown in **Figure 15** and **Figure 16**.

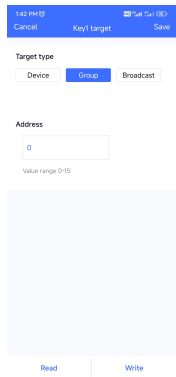

Figure 13

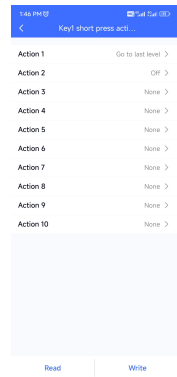

Figure 14



Figure 15

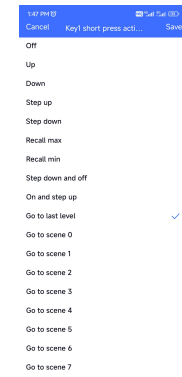

Figure 16

"Go to scene 0-15" is to trigger a DALI scene as shown in **Figure 16** and **Figure 17**. These actions only work when DALI scenes are already configured for the ECGs.

"X-coordinate step up" is to step up x-coordinate value, "Y-coordinate step up" is to step up y-coordinate value as shown in **Figure 17**.

"X-coordinate step down" is to step down x-coordinate value, "Y-coordinate step down" is to step down y-coordinate value as shown in **Figure 17**.

"Cct step cooler" is to step the color temperature value to cooler, "Cct step warmer" is to step the color temperature value to warmer as shown in **Figure 17**.

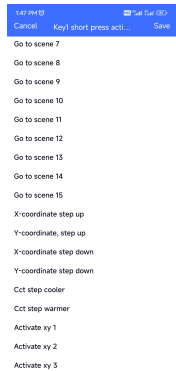

Figure 17



Figure 18



Figure 19

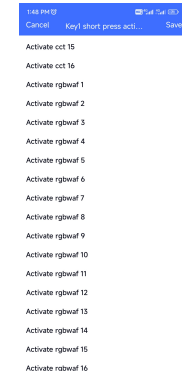

Figure 20

"Activate Xy 1-16" is to trigger a Xy color as shown in **Figure 17** and **Figure 18**. These actions only work when "Xy settings" option values are set.

"Activate cct 1-16" is to trigger a color temperature as shown in **Figure 18** and **Figure 19**. These actions only work when "Cct settings" option values are set.

"Activate Rgbwaf 1-16" is to trigger a RGBWAF color as shown in **Figure 19** and **Figure 20**. These actions only work when "Rgbwaf settings" option values are set.

Once the actions are set as shown in **Figure 14**, "Save" button at upper right corner means save the setting to smart phone, "Read" button at the bottom means read and import this single attribute from an existing control unit though NFC if you do not want to configure by yourself, "Write" button at the bottom means write this single attribute to a control unit though NFC.

Step 4: "Key1 long press actions" setting: tap "Key1 long press actions" as shown in **Figure 10**, we can set the DALI commands triggered by long press of key 1 as shown in **Figure 21**. Up to 10 actions can be set, which means you can set up to 10 actions (Action 1 to Action 10) triggered by 10 times long press in sequence as a cycle, 1st long press triggers Action 1, 2nd long press triggers Action 2,, 10th long press triggers Action 10, 11th long press triggers Action 1, 12th long press triggers Action 2,, 20th long press triggers Action 10,, By factory default, only 2 actions are set, other actions are not set, that means only Action 1 and Action 2 triggered by 2 times long press in sequence as a cycle.

Available settings for long press actions are similar to short press actions as shown in **Figure 22**, **Figure 23**, **Figure 24**, **Figure 25**, **Figure 26** and **Figure 27**, please refer to the settings of short press actions. There are some additional settings for long press actions as follows:

"Rgb loop1 (clockwise)" is to loop RGB channels clockwise, "Rgb loop1 (anticlockwise)" is to loop RGB channels anticlockwise as shown in **Figure 22**.

"Waf loop1 (clockwise)" is to loop WAF channels clockwise, "Waf loop1 (anticlockwise)" is to loop WAF channels anticlockwise as shown in **Figure 22**.

"W loop1 (clockwise)" is to loop W channel clockwise, "W loop1 (anticlockwise)" is to loop W channels anticlockwise as shown in **Figure 22**.

Once the actions are set as shown in **Figure 21**, "Save" button at upper right corner means save the setting to smart phone, "Read" button at the bottom means read and import this single attribute from an existing control unit though NFC if you do not want to configure by yourself, "Write" button at the bottom means write this single attribute to a control unit though NFC.

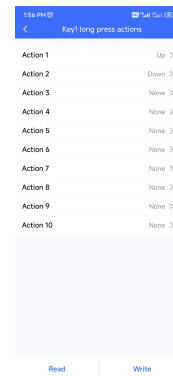

Figure 21

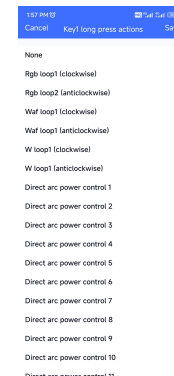

Figure 22

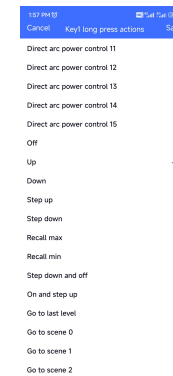

Figure 23

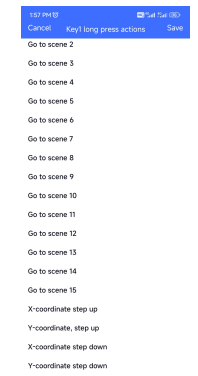

Figure 24



Figure 25



Figure 26



Figure 27

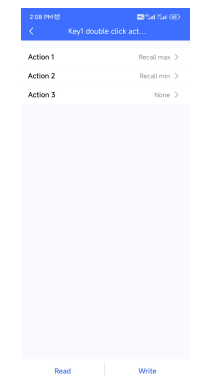

Figure 28



Figure 29

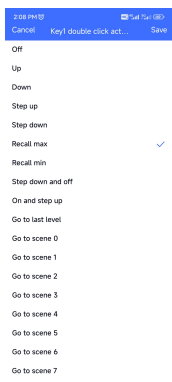

Figure 30

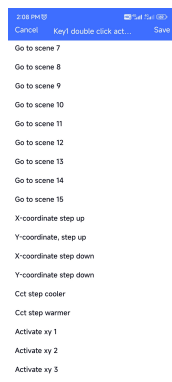

Figure 31



Figure 32

Step 5: "Key1 double click actions" setting: tap **"Key1 double click actions"** as shown in **Figure 10**, we can set the DALI commands triggered by double click of key 1 as shown in **Figure 28**. Up to 3 actions can be set, which means you can set up to 3 actions (Action 1 to Action 3) triggered by 3 times double click in sequence as a cycle, 1st double click triggers Action 1, 2nd double click triggers Action 2, 3rd double click triggers Action 3, 4th double click triggers Action 1, 5th double click triggers Action 2, 6th double click triggers Action 3, By factory default, only 2 actions are set, other actions are not set, that means only Action 1 and Action 2 triggered by 2 times double click in sequence as a cycle.

Available settings for double click actions are similar to short press actions as shown in **Figure 29**, **Figure 30**, **Figure 31**, **Figure 32**, **Figure 33** and **Figure 34**, please refer to the settings of short press actions.

Once the actions are set as shown in **Figure 28**, **"Save"** button at upper right corner means save the setting to smart phone, **"Read"** button at the bottom means read and import this single attribute from an existing control unit though NFC if you do not want to configure by yourself, **"Write"** button at the bottom means write this single attribute to a control unit though NFC.

Step 6: "Key2 target" setting: tap **"Key2 target"** as shown in **Figure 10**, we can set controlled target of key 2, please refer to **Step 6 "Key1 target"** for detailed settings.

Step 7: "Key2 short press actions" setting: tap **"Key2 short press actions"** as shown in **Figure 10**, we can set the DALI commands triggered by short press of key 2, please refer to **Step 7 "Key1 short press actions"** for detailed settings.

Step 8: "Key2 long press actions" setting: tap **"Key2 long press actions"** as shown in **Figure 10**, we can set the DALI commands triggered by long press of key 2, please refer to **Step 8 "Key1 long press actions"** for detailed settings.

Step 9: "Key2 double click actions" setting: tap **"Key2 double click actions"** as shown in **Figure 10**, we can set the DALI commands triggered by double click of key 2, please refer to **Step 9 "Key1 double click actions"** for detailed settings.



Figure 33

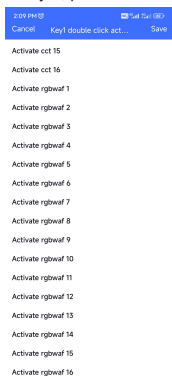

Figure 34



Figure 35

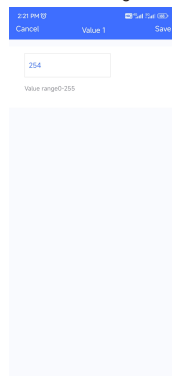

Figure 36

Step 10: "Direct power settings" setting: tap **"Direct power settings"** as shown in **Figure 10**, we can set 15 brightness values as shown in **Figure 35**, tap on a value to enter setting interface as shown in **Figure 36**, setting range is 0-255, 0-254 means 0-100%, 255 means mask. Tap on **"Save"** button at the upper right corner to save the setting as shown in **Figure 36**.

Once the values are set as shown in **Figure 35**, **"Read"** button at the bottom means read this single attribute from an existing control unit though NFC, **"Write"** button at the bottom means write this single attribute to a control unit though NFC.



Figure 37



Figure 38

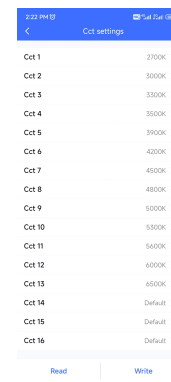

Figure 39

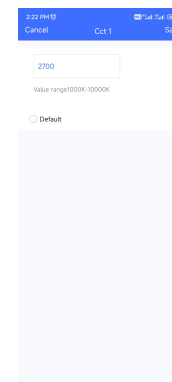

Figure 40

Step 10: "Xy settings" setting: tap **"Xy settings"** as shown in **Figure 10**, we can set 16 XY coordinate values as shown in **Figure 37**, tap on a value to enter setting interface as shown in **Figure 38**, setting range is 0-1. Tap on **"Save"** button at the upper right corner to save the setting as shown in **Figure 38**.

Once the values are set as shown in **Figure 37**, **"Read"** button at the bottom means read and import this single attribute from an existing control unit though NFC if you do not want to configure by yourself, **"Write"** button at the bottom means write this single attribute to a control unit though NFC.

Step 11: "Cct settings" setting: tap **"Cct settings"** as shown in **Figure 10**, we can set 16 color temperature values as shown in **Figure 39**, tap on a value to enter setting interface as shown in **Figure 40**, setting range is 1000-10000K. Tap on **"Save"** button at the upper right corner to save the setting as shown in **Figure 40**.

Once the values are set as shown in **Figure 39**, **"Read"** button at the bottom means read and import this single attribute from an existing control unit though NFC if you do not want to configure by yourself, **"Write"** button at the bottom means write this single attribute to a control unit though NFC.

Step 12: "Rgbwaf settings" setting: tap **"Rgbwaf settings"** as shown in **Figure 10**, we can set 16 RGBWAF values as shown in **Figure 41**, tap on a value to enter setting interface as shown in **Figure 42** and **Figure 43**, you can set RGBWAF channels separately, setting range for each channel is 0-254 (0-100%). Tap on **"Save"** button at the upper right corner to save the setting as shown in **Figure 43**.

Once the values are set as shown in **Figure 41**, **"Read"** button at the bottom means read and import this single attribute from an existing control unit though NFC if you do not want to configure by yourself, **"Write"** button at the bottom means write this single attribute to a control unit though NFC.

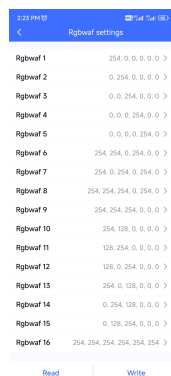

Figure 41

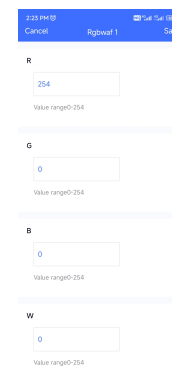

Figure 42

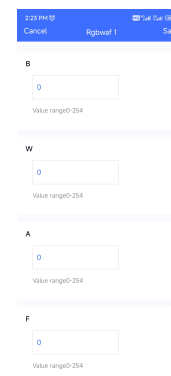

Figure 43



Figure 44

3. Select Push Dim or Corridor Dim Mode and Set Parameters of CD Mode

Step 1: "Corridor 1" setting: tap **"Corridor 1"** as shown in **Figure 10**, we can set the operation mode of K1 input of the control unit as shown in **Figure 44**, factory default mode is **"PD"** mode. If users set the mode to **"CD"** mode, K1 input can be connected with a dry contact motion sensor and detects motion to control the targets of Key 1. The available setting parameters for the motion sensor are as follows as shown in **Figure 45** and **Figure 46**:

"Fade in time" is to set the fade time that the target DALI ECGs fade in to the set occupied level from current status after motion detected as shown in **Figure 45**. Tap on **"Fade in time"** to enter the value setting page, available setting is 0S~90.5S, factory default setting is 1S as shown in **Figure 47**.

"Occupied time" is to set the how long will the occupied level last as shown in **Figure 45**. Available setting is 0S~60000S, factory default setting is 180S as shown in **Figure 45**.

"Occupied level" is to set the brightness that the target DALI ECGs will turn to after motion detected as shown in **Figure 45**. Available setting is 0~100%, factory default setting is 100% as shown in **Figure 45**.

"Fade out time" is to set the fade time that the target DALI ECGs fade out to the set prolonged level from occupied level after occupied time expires as shown in **Figure 45**. Tap on "Fade out time" to enter the value setting page, available setting is 0S~90.5S, factory default setting is 4S as shown in **Figure 48**.

"Prolonged time" is to set how long will the prolonged level last as shown in **Figure 46**. Available setting is 0S~60000S and infinite, factory default setting is 5S as shown in **Figure 46**. Infinite means the prolonged level will last forever and never fade off.

"Prolonged level" is to set the brightness that the target DALI ECGs will turn to after occupied time expires as shown in **Figure 46**. Available setting is 0~100%, factory default setting is 10% as shown in **Figure 46**.

"Dim-to-off time" is to set the fade time that the target DALI ECGs fade to off from prolonged level after prolonged time expires as shown in **Figure 46**. Tap on "Dim-to-off time" to enter the value setting page, available setting is 0S~90.5S, factory default setting is 0S as shown in **Figure 49**.

5. Control the Connected DALI ECGs Using the Control Unit

Step 1: connect the programmed control units to push switches or dry contact motion sensors, mains power and DALI ECGs, then power on, you can control the DALI ECGs (DT6, DT8 Tc, DT8 XY, DT8 RGBWAF) using the push switches or motion sensors depending on your configurations.

Product Dimension

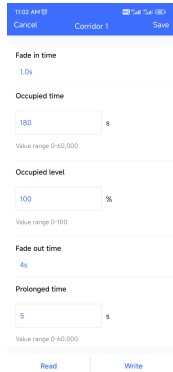
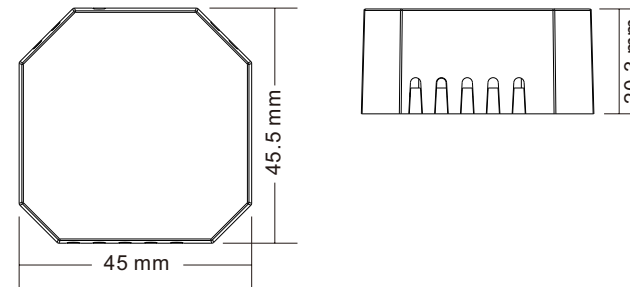

Figure 45

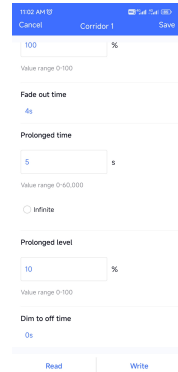

Figure 46



Figure 47



Figure 48

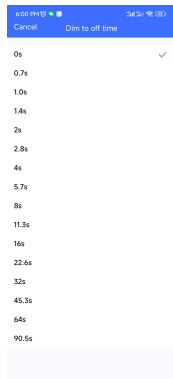

Figure 49

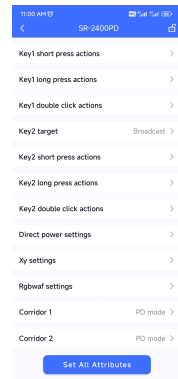

Figure 50

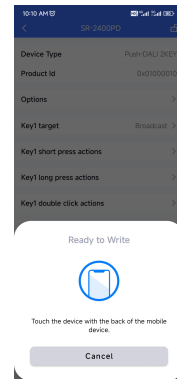

Figure 51

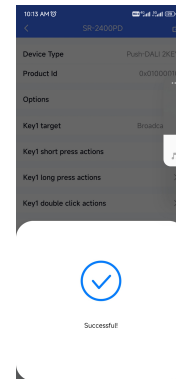

Figure 52

Step 2: "Corridor 2" setting: tap "Corridor 2" as shown in **Figure 10**, we can set the operation mode of K2 input of the control unit as shown in **Figure 44**, factory default mode is "PD" mode. If users set the mode to "CD" mode, K2 input can be connected with a dry contact motion sensor and detects motion to control the targets of Key 2. The available setting parameters for the motion sensor are the same as K1's motion sensor setting, please refer to the settings of the K1's motion sensor.

4. Write the Settings to the Control Unit

Step 1: once all settings are completed as shown in **Figure 50**, we need to write all attributes to the control unit through NFC, tap on "Set All Attributes" as shown in **Figure 51**, then touch the control unit NFC position with the NFC reception area of the smart phone as the app instructed as shown in **Figure 51**. Once write successfully, there shall be a pop-up window to indicate as shown in **Figure 52**.