

ECH350VT-XXPL

Leiterplatten-Anschlussblöcke > Leiterplatten-Anschlussbuchse

Date:2025-02-25

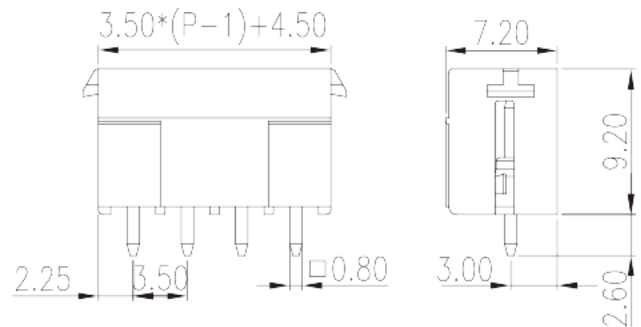
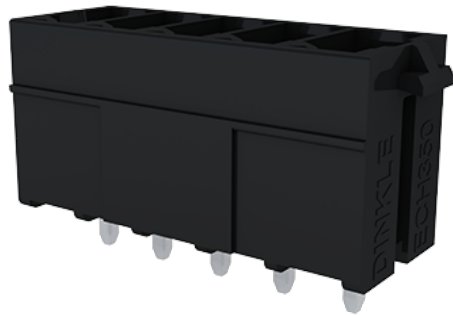

The web catalog is for reference only. Dinkle remains the right of product modification and engineering change of the design.
The final product is made according to engineering drawing.

Produktbeschreibung

Pitch : 3.50mm, 300V, 8A

Allgemeine Informationen

Kurzbeschreibung	PCB Connector–Socket, Reflow soldering
Kategorie	PCB Connector–Socket
Pitch (mm)	3.50
Farbe	Black (default)
Verriegelungstyp	With lock flange
Lötverfahren	Reflow Soldering (Temperature condition according to standard IPC/JEDEC J-STD-020E)
Länge (mm)	$3.50 \times (P-1) + 6.5$
Breite (mm)	7.2
Höhe (mm)	9.2
Pin-Abmessungen (Stärke x Breite)	0.8 x 0.8
Lochdurchmesser Leiterplatte (mm)	1.4
Foto Anzahl der Pole	02P~24P
Level	Single level

Materialinformation

Isoliermaterial	HIGH-TEMPERATURE PLASTICS
Grupper der Isoliermaterialien	IIIa
Entflammbarkeitsklasse, UL94 konform	V0
Isolationswiderstand	□500MΩ at DC 500V
Leitermaterial	COPPER ALLOY
Oberflächenveredelung	Tin PLATED
MSL	1

Verbindungsdaten nach IEC

Nennspannung (V)	320
Nennstrom (A)	14
Nennspannung (II/2) (V)	320
Nennspannung (III/2) (V)	160
Nennspannung (III/3) (V)	160
Bemessungsstossspannung (II/2) (kV)	2.5
Bemessungsstossspannung (III/2) (kV)	2.5
Bemessungsstossspannung (III/3) (kV)	2.5

Verbindungsdaten nach UL

Nennspannung (UL/CUL Gruppe B) (V)	300
Nennstrom (UL/CUL Gruppe B) (A)	8
Nennspannung (UL/CUL Gruppe D) (V)	300
Nennstrom (UL/CUL Gruppe D) (A)	8

Umwelt & Sicherheit

Fingerschutz	NO
Betriebstemperatur max. (°C)	120
Betriebstemperatur min. (°C)	-40

Zeichnungen

--	--

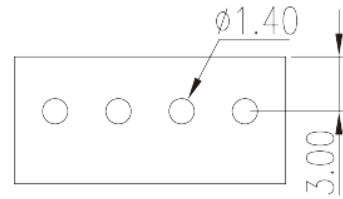
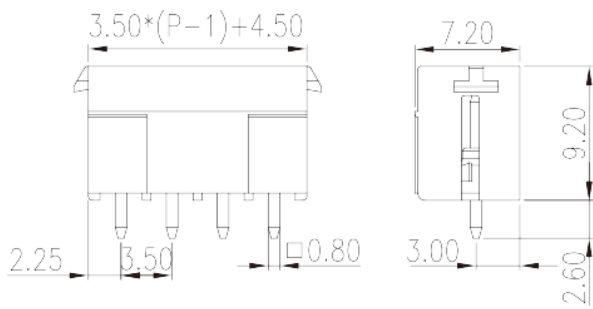

Zulassungen

