



(Independent type)

IS 15885



NOTE.14

UL US



LISTED CLASS P LED DRIVER 4983 E334687



Features

- Constant power mode output with multiple stage selectable by NFC setting (H-type)
- Constant voltage mode output(12V/24V)
- Plastic housing with class II and PFC design
- Meet UL 8750 Class 2 / Class P power unit
- Flicker free, complying with CE ErP directive
- Standby power consumption <0.5W
- Meet emergency lighting (EL) function application
- Fully encapsulated with IP67
- Minimum dimming level 0.1% (DALI-2 DT6)
- Dimming functions: 3 in 1 dimming (Dim-to-off) DALI-2 + Push dimming
- 5 years warranty

Applications

- Recessed Light
- Down Light
- Panel Light
- Commercial Lighting
- Decorative Lighting
- LED strip lighting
- DALI digital Lighting

GTIN CODE

MW Search: <https://www.meanwell.com/serviceGTIN.aspx>

Description

XLN-40 Series is a 40W with constant power and constant voltage output LED driver . It can operate from 100~305VAC and output current ranging between 600 mA to 1400 mA selectable by NFC setting. Thanks to high efficiency up to 88%, it is able to operate for -25°C ~90°C case temperature under free air convection. XLN-40 is designed based on latest safety regulation with 3 in 1 and DALI-2 dimming. XLN-40 can also be adjusted for brightness with a push button as a simple way dimming, so it provides more flexibility for LED Lighting application.

Model Encoding

XLN - 40 - H -

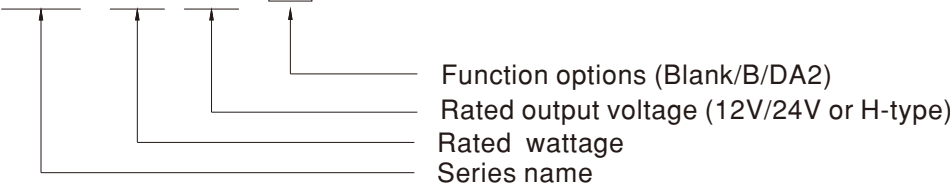

| Type | Function | Note |
|-------|-------------------------------------------------------------------------------------------------------------|----------|
| Blank | H type output current selectable by NFC setting with constant power mode 12, 24V Constant voltage output | In stock |
| B | H type output current selectable by NFC setting and built in 3 in 1 dimming | |
| DA2 | H type output current selectable by NFC setting and built in DALI-2 dimming | |

- Note: 1. 12V/24V output is fixed without NFC function and Dimming.
2. For more current setting, please contact MW sales representative.

SPECIFICATION

| MODEL | | XLN-40-12 | XLN-40-24 | |
|----------------------------------------|----------------------------------------------------------------------------------------------------------------------------------------------------------------------------------------------------------------------------------------------------------------------------------------------------------------------------------------------------------------------------------------------------------------------------------------------------------------------------------------------------------------------------------------------------------------------------------------------------------------------------------------------------------------------------------------------------------------------------------------------------------------------------------------------------------------------------------------------------------------------------------------------------------------------------------------------------------------------------------------------------------------------------------------------------------------------------------------------------------------------------------------------------------------------------------------------------------------------------------------------------------------------------------------------------------------------------------------------------------------------------------------------------------------------------------------------------------------------------------------------------------------------------------------------------------------------------------------------------------------------------------------------------------------------------------------------------------------------------------------------------------------------------------------------------------------------------------------------------------------------------------------------------------------------------------------------------------------------------------------------------------------------------------------------------------------------------------------------------------------------------------------------------------------------------------------------------------------------------------------------------------------------------------------------------------------------------------------------------------------------------------------------------------------|----------------------------------------------------------------------------------------------------------------------------------------------------------------------------------------------------------------------------------------------------------------------------------------------------------------------------------|-------------------------------------------------------------------------|-----------------------------------------|
| OUTPUT | RATED VOLTAGE | 12V | 24V | |
| | RATED CURRENT | 3.4A | 1.7A | |
| | RATED POWER <small>Note.2</small> | 40.8W | 40.8W | |
| | RIPPLE & NOISE (max.) <small>Note.3</small> | 120mVp-p | 240mVp-p | |
| | VOLTAGE TOLERANCE <small>Note.4</small> | ±4.0% | | |
| | LINE REGULATION | ±0.5% | | |
| | LOAD REGULATION | ±2% | | |
| SETUP, RISE TIME <small>Note.5</small> | 500ms, 100ms/230VAC, 1000ms, 100ms/115VAC | | | |
| INPUT | VOLTAGE RANGE | 100 ~ 305VAC 141 ~ 400VDC | | |
| | FREQUENCY RANGE | 47 ~ 63Hz | | |
| | POWER FACTOR | PF ≥ 0.97/115VAC, PF ≥ 0.95/230VAC, PF ≥ 0.92/277VAC@full load (Please refer to "POWER FACTOR (PF) CHARACTERISTIC" section) | | |
| | TOTAL HARMONIC DISTORTION | THD<10%(@load ≥ 50%/230VAC; @load ≥ 75%/277VAC), THD<15%(@load ≥ 50%/115VAC) (Please refer to "TOTAL HARMONIC DISTORTION(THD)" section) | | |
| | EFFICIENCY (Typ.) | 86% | 88% | |
| | AC CURRENT | 0.5A / 115VAC 0.25A / 230VAC 0.2A/277VAC | | |
| | INRUSH CURRENT(Typ.) | COLD START 10A(twidth=100µs measured at 50% Ipeak) at 230VAC; Per NEMA 410 | | |
| | MAX. No. of PSUs on 16A CIRCUIT BREAKER | 51 units (circuit breaker of type B) / 51 units (circuit breaker of type C) at 230VAC | | |
| LEAKAGE CURRENT | <0.75mA / 277VAC | | | |
| PROTECTION | OVER LOAD | 105 ~ 220% rated output power Protection type:Hiccup mode , recovers automatically after fault condition is removed | | |
| | SHORT CIRCUIT | Hiccup mode, recovers automatically after fault condition is removed | | |
| | OVER VOLTAGE | 13 ~ 16V | 26 ~ 32V | |
| | OVER TEMPERATURE | Shut down output voltage, recovers automatically after fault condition is removed | | |
| ENVIRONMENT | WORKING TEMP. | Tcase=-25 ~ 90°C (Please refer to " OUTPUT LOAD vs TEMPERATURE" section) | | |
| | MAX. CASE TEMP. | Tcase=90°C | | |
| | WORKING HUMIDITY | 20 ~ 90% RH non-condensing | | |
| | STORAGE TEMP., HUMIDITY | -40 ~ +80°C, 10 ~ 95% RH | | |
| | TEMP. COEFFICIENT | ±0.03%/°C (0 ~ 50°C) | | |
| VIBRATION | 10 ~ 500Hz, 2G 10min./1cycle, period for 60min. each along X, Y, Z axes | | | |
| SAFETY & EMC | SAFETY STANDARDS | ENEC BS EN/EN61347-1, BS EN/EN61347-2-13(EL) appendix J suitable for emergency installations(DC input 176-280VDC); BS EN/EN62384, BIS IS15885(Part2/Sec13)(NOTE 14), GB/T19510.1, GB/T19510.2,13, EAC TP TC 004,UL8750(Type HL and Class P); CSA C22.2 No. 250.13-12 approved;Design refer to AS/NZS 61347-1, AS/NZS 61347-2-13; | | |
| | WITHSTAND VOLTAGE | I/P-O/P:3.75KVAC | | |
| | ISOLATION RESISTANCE | I/P-O/P:>100M Ohms / 500VDC / 25°C / 70% RH | | |
| | EMC EMISSION | Parameter | Standard | Test Level/Note |
| | | Conducted | BS EN/EN55015(CISPR15) ,GB/T 17743 | ----- |
| | | Radiated | BS EN/EN55015(CISPR15) ,GB/T 17743 | ----- |
| | | Harmonic Current | BS EN/EN61000-3-2 , GB17625.1 | Class C @load≥50% |
| | Voltage Flicker | BS EN/EN61000-3-3 | ----- | |
| | EMC IMMUNITY | Parameter | Standard | Test Level/Note |
| | | ESD | BS EN/EN61000-4-2 | Level 3, 8KV air ; Level 2, 4KV contact |
| Radiated | | BS EN/EN61000-4-3 | Level 2 | |
| EFT/Burst | | BS EN/EN61000-4-4 | Level 2 | |
| Surge | | BS EN/EN61000-4-5 | Level 3, 1KV/Line-Line | |
| Conducted | | BS EN/EN61000-4-6 | Level 2 | |
| Magnetic Field | | BS EN/EN61000-4-8 | Level 2 | |
| Voltage Dips and Interruptions | | BS EN/EN61000-4-11 | 70% residual voltage for 10 period, 0% residual voltage for 0.5 periods | |
| OTHERS | FLICKER <small>Note.6</small> | PstLM ≤ 1, SVM ≤ 0.4 | | |
| | MTBF | 3935.2 K hrs min. Telcordia SR-332 (Belcore) ; 342.9 Khrs min. MIL-HDBK-217F (25°C) | | |
| | DIMENSION | 114*44*32mm (L*W*H) | | |
| | PACKING | 308g; 40pcs/13.32Kg/0.95CUFT | | |
| NOTE | <p>1. All parameters NOT specially mentioned are measured at 230VAC input, rated current and 25°C of ambient temperature.</p> <p>2. De-rating may be need under low input voltages. Please refer to "STATIC CHARACTERISTIC" sections for details.</p> <p>3. Ripple & noise are measured at 20MHz of bandwidth by using a 12" twisted pair-wire terminated with a 0.1µF & 47µF parallel capacitor.</p> <p>4. Tolerance: includes set up tolerance, line regulation and load regulation.</p> <p>5. Length of set up time is measured at first cold start. Turning ON/OFF the driver may lead to increase of the set up time.</p> <p>6. Flicker is measured at full load with the light source provided by MEAN WELL.</p> <p>7. To fulfill requirement of the latest ErP regulation for lighting fixtures, this LED driver can only be used behind a switch without permanently connected to the mains.</p> <p>8. The driver is considered as a component that will be operated in combination with final equipment. Since EMC performance will be affected by the complete installation, the final equipment manufacturers must re-qualify EMC Directive on the complete installation again. (as available on https://www.meanwell.com/Upload/PDF/EMI_statement_en.pdf)</p> <p>9. The ambient temperature de-rating of 3.5°C/1000m with fanless models and 5°C/1000m with fan models for operating altitude higher than 2000m(6500ft).</p> <p>10. This series meets the typical life expectancy of >50,000 hours of operation when Tcase, particularly (C) point (or TMP, per DLC), is about 75°C or less.</p> <p>11. RCM is on a voluntary basis. Non IC classification Independent LED control gear is not suitable for residential installations.</p> <p>12. Products sourced from the Americas regions may not have the CCC/PSE/BIS/KC logo. Please contact your MEAN WELL sales for more information.</p> <p>13. For more information, please contact with MEAN WELL sales.</p> <p>14. Products sourced from the China regions may not have the BIS logo, please contact your MEAN WELL sales for more information.</p> <p>※Product Liability Disclaimer: For detailed information, please refer to https://www.meanwell.com/serviceDisclaimer.aspx</p> | | | |

SPECIFICATION

| | | | | | |
|--------------------------------|---------------------------------------------------------------------------------------------------------------------------------------------------------------------------------------------------------------------------------------------------------------------------------------------------------------------------------------------------------------------------------------------------------------------------------------------------------------------------------------------------------------------------------------------------------------------------------------------------------------------------------------------------------------------------------------------------------------------------------------------------------------------------------------------------------------------------------------------------------------------------------------------------------------------------------------------------------------------------------------------------------------------------------------------------------------------------------------------------------------------------------------------------------------------------------------------------------------------------------------------------------------------------------------------------------------------------------------------------------------------------------------------------------------------------------------------------------------------------------------------------------------------------------------------------------------------------------------------------------------------------------------------------------------------------------------------------------------------------------------------------------------------------------------------------------------------------------------------------------------------------------------------------------------------------------------------------------------------------------------------------------------------------------------------------------------------------------------------------------------------------------------------------------------------------------------------------------------------------------------------------------------------------------------------------------------------------------------------------------------------------------------------------------------------------------------------------------------------------------------------------------------------------------------------------------------------------------------------------------------------------------------------------------|---------------------------------------------------------------------------------------------------------------------------------------------------------------------------------------------------------------------------------------------------------------------------------------------------------------------------------|-------------------------------------------------------------------------|------------------------------------|-----------------------------------------|
| MODEL | | XLN-40-H- <input type="checkbox"/> | | | |
| OUTPUT | OPEN CIRCUIT VOLTAGE Note.2 | 60V | | | |
| | DEFAULT CURRENT | 1050mA | | | |
| | CURRENT ADJ. RANGE (BY NFC) | 0.6~1.4A | | | |
| | CONSTANT CURRENT REGION Note.3 | 9~54V | | | |
| | RATED POWER Note.4 | 40W | | | |
| | CURRENT RIPPLE | <4%(@full load) | | | |
| | CURRENT TOLERANCE | ±5% | | | |
| | DIMMING RANGE | 0~100% | | | |
| | SETUP, RISE TIME Note.5,6 | 500ms, 100ms/230VAC, 1000ms, 100ms/115VAC | | | |
| INPUT | VOLTAGE RANGE | 100 ~ 305VAC 141 ~ 400VDC | | | |
| | FREQUENCY RANGE | 47 ~ 63Hz | | | |
| | POWER FACTOR | PF ≥ 0.97/115VAC, PF ≥ 0.95/230VAC, PF ≥ 0.92/277VAC@full load (Please refer to "POWER FACTOR (PF) CHARACTERISTIC" section) | | | |
| | TOTAL HARMONIC DISTORTION | THD<10%(@load ≥ 50%/230VAC; @load ≥ 75%/277VAC), THD<15%(@load ≥ 50%/115VAC) (Please refer to "TOTAL HARMONIC DISTORTION(THD)" section) | | | |
| | EFFICIENCY (Typ.) Note.7 | 88% | | | |
| | AC CURRENT | 0.5A/ 115VAC 0.25A/ 230VAC 0.2A/277VAC | | | |
| | INRUSH CURRENT(Typ.) | COLD START 10A(twidth=100µs measured at 50% Ipeak) at 230VAC; Per NEMA 410 | | | |
| | MAX. No. of PSUs on 16A CIRCUIT BREAKER | 51 units (circuit breaker of type B) / 51 units (circuit breaker of type C) at 230VAC | | | |
| | LEAKAGE CURRENT | <0.75mA/ 277VAC | | | |
| | STANDBY POWER CONSUMPTION Note.8 | Standby power consumption<0.5W(Dimming off) | | | |
| PROTECTION | SHORT CIRCUIT | Hiccup mode, recovers automatically after fault condition is removed | | | |
| | OVER TEMPERATURE | Blank & B type: De-rating to lowest output level. Recovers automatically after fault condition is removed. DA2 type: Stage 1: De-rating to 75% loading; Stage 2: De-rating to 50% loading. Recovers automatically after fault condition is removed. | | | |
| ENVIRONMENT | WORKING TEMP. | Tcase=-25 ~ 90°C (Please refer to " OUTPUT LOAD vs TEMPERATURE" section) | | | |
| | MAX. CASE TEMP. | Tcase=90°C | | | |
| | WORKING HUMIDITY | 20 ~ 90% RH non-condensing | | | |
| | STORAGE TEMP., HUMIDITY | -40 ~ +80°C, 10 ~ 95% RH | | | |
| | TEMP. COEFFICIENT | ±0.03%/°C (0 ~ 50°C) | | | |
| | VIBRATION | 10 ~ 500Hz, 2G 10min./1cycle, period for 60min. each along X, Y, Z axes | | | |
| SAFETY & EMC | SAFETY STANDARDS | ENEC BS EN/EN61347-1, BS EN/EN61347-2-13(EL) appendix J suitable for emergency installations(DC input 176-280VDC); BS EN/EN62384, BIS IS15885(Part2/Sec13)(NOTE 14), GB/T19510.1, GB/T19510.2, EAC TP TC 004,UL8750(Type HL and Class P); CSA C22.2 No. 250.13-12 approved; Design refer to AS/NZS 61347-1, AS/NZS 61347-2-13 ; | | | |
| | DALI STANDARDS | Comply with IEC62386-101,102,207 | | | |
| | WITHSTAND VOLTAGE | I/P-O/P:3.75KVAC | | | |
| | ISOLATION RESISTANCE | I/P-O/P:>100M Ohms / 500VDC / 25°C / 70% RH | | | |
| | EMC EMISSION | Parameter | | Standard | Test Level/Note |
| | | Conducted | | BS EN/EN55015(CISPR15) ,GB/T 17743 | ----- |
| | | Radiated | | BS EN/EN55015(CISPR15) ,GB/T 17743 | ----- |
| | | Harmonic Current | | BS EN/EN61000-3-2 ,GB17625.1 | Class C @load≥50% |
| | | Voltage Flicker | | BS EN/EN61000-3-3 | ----- |
| | EMC IMMUNITY | BS EN/EN61547 | | | |
| | | Parameter | | Standard | Test Level/Note |
| | | ESD | | BS EN/EN61000-4-2 | Level 3, 8KV air ; Level 2, 4KV contact |
| | | Radiated | | BS EN/EN61000-4-3 | Level 2 |
| | | EFT/Burst | | BS EN/EN61000-4-4 | Level 2 |
| Surge | | BS EN/EN61000-4-5 | Level 3, 1KV/Line-Line | | |
| Conducted | | BS EN/EN61000-4-6 | Level 2 | | |
| Magnetic Field | | BS EN/EN61000-4-8 | Level 2 | | |
| Voltage Dips and Interruptions | | BS EN/EN61000-4-11 | 70% residual voltage for 10 period, 0% residual voltage for 0.5 periods | | |
| OTHERS | FLICKER Note.9 | PstLM ≤ 1, SVM ≤ 0.4 | | | |
| | MTBF | 3935.2 K hrs min. Telcordia SR-332 (Bellcore) ; 342.9 Khrs min. MIL-HDBK-217F (25°C) | | | |
| | DIMENSION | 114*44*32mm (L*W*H) | | | |
| | PACKING | 311g; 40pcs/13.44Kg/0.95CUFT | | | |
| NOTE | <p>1. All parameters NOT specially mentioned are measured at 230VAC input, rated current and 25°C of ambient temperature.</p> <p>2. Output hiccups under no-load condition.</p> <p>3. Please refer to "DRIVER METHODS OF LED MODULE".</p> <p>4. De-rating may be need under low input voltages. Please refer to "STATIC CHARACTERISTIC" sections for details.</p> <p>5. Length of set up time is measured at first cold start. Turning ON/OFF the driver may lead to increase of the set up time.</p> <p>6. Based on IEC 62386-101/102 DALI power on timing and interruption regulations, the set up time needs to test with a DALI controller which can support for DALI power on function, otherwise the startup time will be higher than 0.5 second.</p> <p>7. Efficiency is measured at 800mA/50V by NFC.</p> <p>8. Standby power consumption is measured at 230VAC.</p> <p>9. Flicker is measured at full load with the light source provided by MEAN WELL.</p> <p>10. The driver is considered as a component that will be operated in combination with final equipment. Since EMC performance will be affected by the complete installation, the final equipment manufacturers must re-qualify EMC Directive on the complete installation again. (as available on https://www.meanwell.com/Upload/PDF/EMI_statement_en.pdf)</p> <p>11. RCM is on a voluntary basis. Non IC classification Independent LED control gear is not suitable for residential installations.</p> <p>12. This series meets the typical life expectancy of >50,000 hours of operation when Tcase, particularly (C) point (or TMP, per DLC), is about 75°C or less.</p> <p>13. The ambient temperature de-rating of 3.5°C/1000m with fanless models and 5°C/1000m with fan models for operating altitude higher than 2000m(6500ft).</p> <p>14. Products sourced from the China regions may not have the BIS logo, please contact your MEAN WELL sales for more information.</p> <p>15. To fulfill requirements of the latest ErP regulation for lighting fixture, this LED driver can only be used behind a switch without permanently connected to the mains.</p> <p>16. Products sourced from the Americas regions may not have the CCC/PSE/BIS/KC logo. Please contact your MEAN WELL sales for more information.</p> <p>17. For more information, please contact with MEAN WELL sales.</p> <p>※Product Liability Disclaimer: For detailed information, please refer to https://www.meanwell.com/serviceDisclaimer.aspx</p> | | | | |

■ BLOCK DIAGRAM

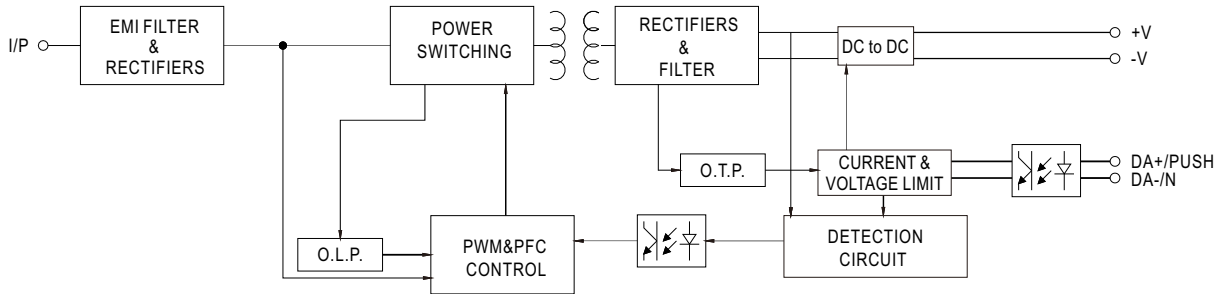

■ DRIVING METHODS OF LED MODULE

※ I-V Operating Area

◎ XLN-40-H

For 40W application

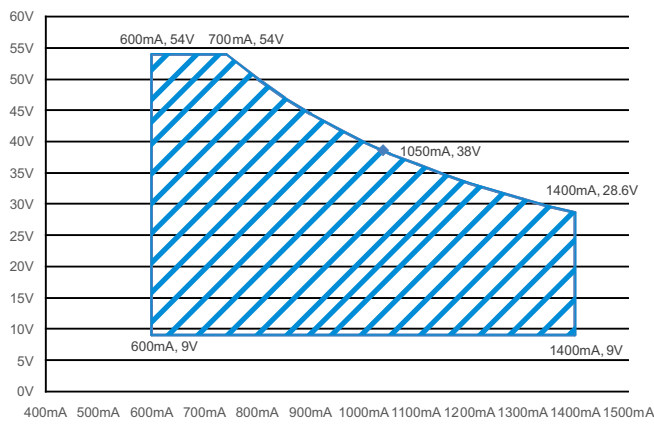

■ CONSTANT POWER TABLE

XLN-40-H is a multiple-stage constant power driver, selection of output current through NFC setting is exhibited below.

| Vo | Io |
|-------|-----------------|
| 9~54V | 600mA |
| 9~54V | 700mA |
| 9~50V | 800mA |
| 9~45V | 900mA |
| 9~38V | 1050mA(default) |
| 9~33V | 1200mA |
| 9~31V | 1300mA |
| 9~29V | 1400mA |

Note: 1. The operating voltage range which show on this table is recommend to use.

NFC Function Description

1. The output current of the NFC Mode LED driver can be adjusted using NFC via the mobile APP.

Operation Instruction:

● Compatible phone

Install an NFC-compatible smart mobile device or phone with AndroidTM 4.1 or IOS12 updates.

● Steps for setting output current via NFC

1. Download Meanwell APP on mobile device or mobile phone, and enable NFC function.

2. Check the NFC antenna position of the mobile phone please.

3. Enter Meanwell APP -> Top left menu -Installation Manual/APP->PowerNFC, approach the LED driver NFC sensing position and perform sensing.

4. APP displays the functional parameters, and the relevant parameters are modified as required.

5. Tap the APP write button and quickly move the phone antenna close to the NFC sensing position of the LED driver.

6. The write completes when the mobile phone displays "Success".

APP Function Description

※ APP Interface:

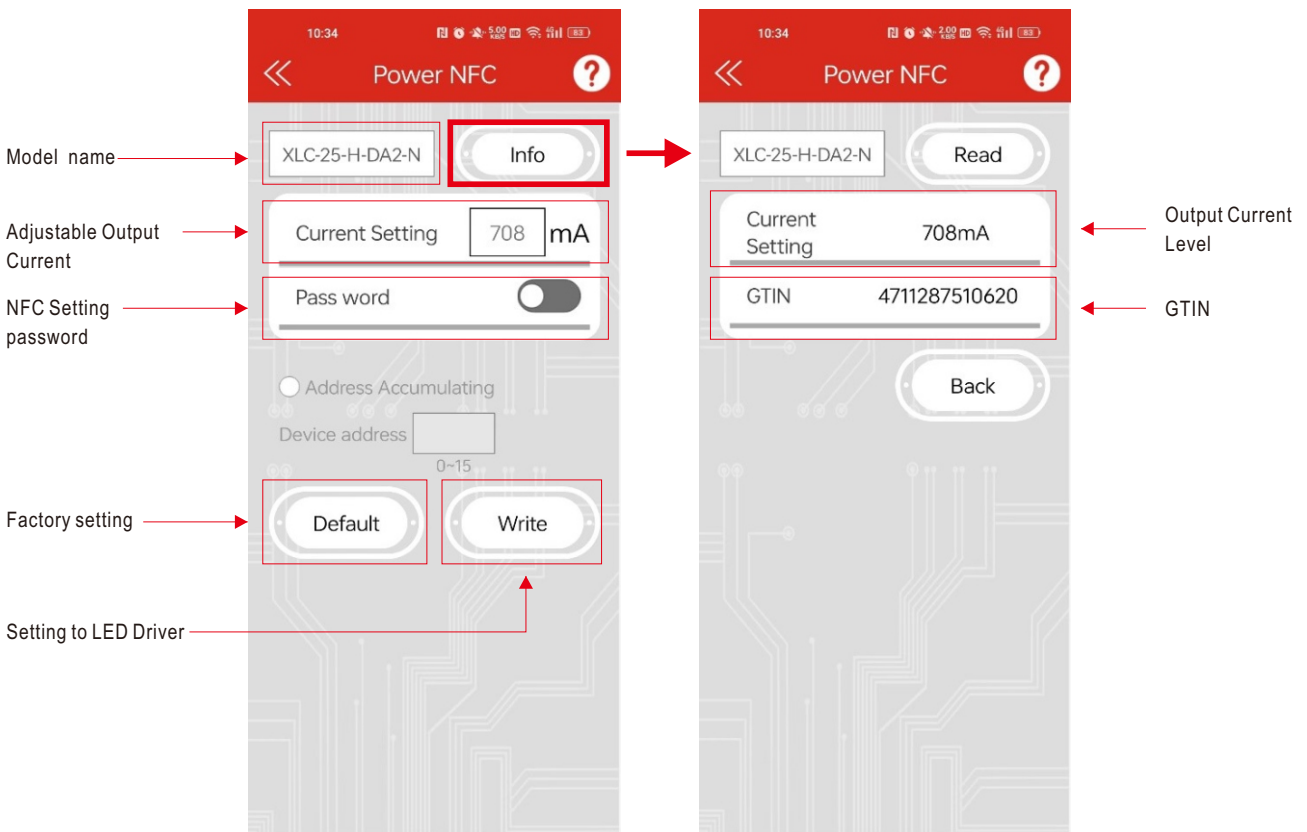

• To be used through APP available on Apple Store and Google Play Store for iOS and Android.
Search: MEAN WELL on



Note: 1. Current accuracy : the numerical error between the set current and the actual current is within 2%.
2. Please turn off the input power supply to the LED driver when using NFC function.

■ DIMMING OPERATION

◎ **B type**

※ **3 in 1 dimming function**

- Output constant current level can be adjusted by applying one of the three methodologies between DIM+ and DIM-: 0 ~ 10VDC, or 10V PWM signal or resistance.
- Direct connecting to LEDs is suggested. It is not suitable to be used with additional drivers.
- Dimming source current from power supply: 100 μ A (typ.)

◎ Applying additive 0 ~ 10VDC

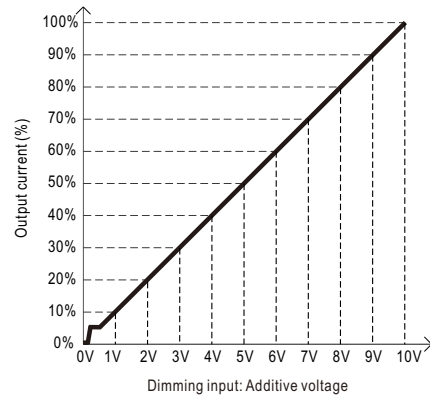
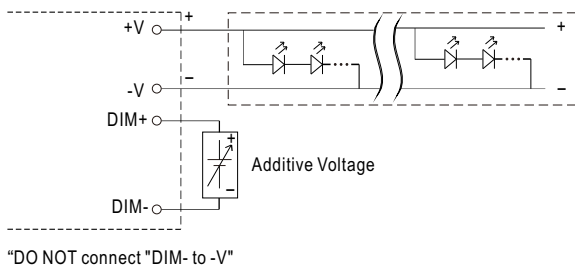

◎ Applying additive 10V PWM signal (frequency range 300Hz~3KHz):

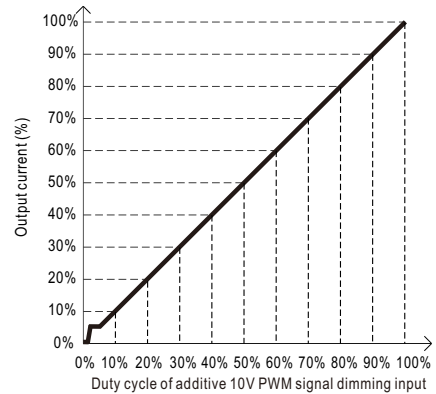
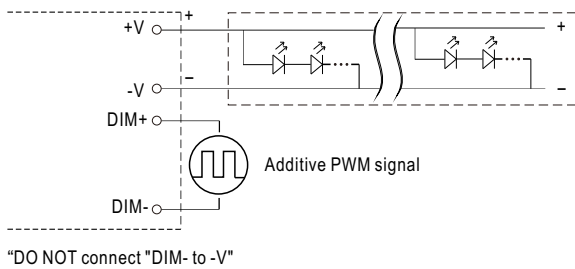

◎ Applying additive resistance: 0~100k Ω

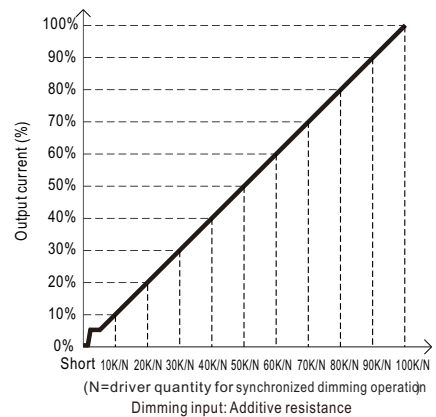
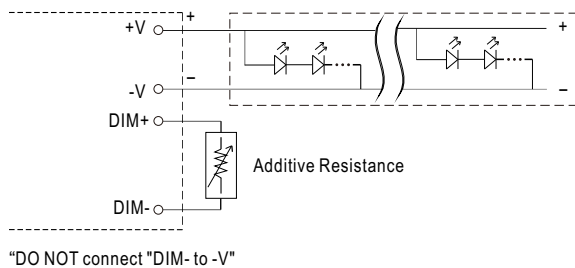

Note : 1. Min. dimming level is about 8% and the output current is not defined when 0% < I_{out} < 8%.
 2. The output current could drop down to 0% when dimming input is about 0k Ω or 0Vdc, or 10V PWM signal with 0% duty cycle.

■ DIMMING OPERATION

◎ DA2 type (DALI-2 digital dimming function)

※ Input wiring diagram

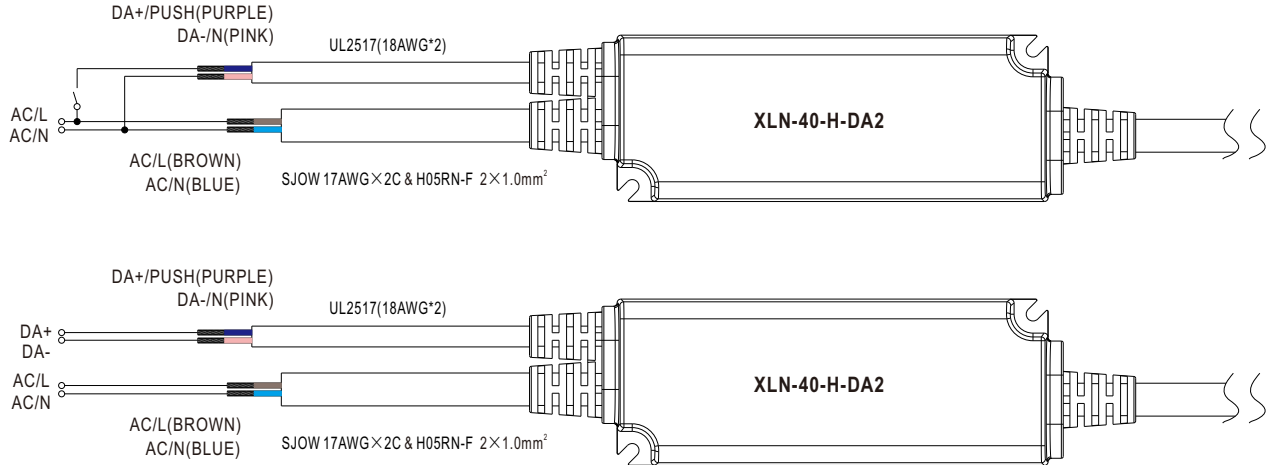

※ PUSH dimming (primary side)

- The factory default dimming level is at 100%.
- If the push action lasts less than 0.05 sec., it will not lead to a change for the status of the driver.
- Up to 10 drivers can perform the PUSH dimming at the same time when utilizing one common push button.
- The maximum length of the cable from the push button to the last driver is 20 meters.

| Action | Action duration | Function |
|--------------|---------------------|-------------------------------------------------------------------|
| Short Push | 0.1~1s | Turn ON-OFF the driver |
| Double Click | Click twice in 1.5s | Set up the dimming level to 100% |
| Long Push | 1.5~10s | Every Long Push changes the dimming direction, dimming up or down |

■ **OUTPUT LOAD vs TEMPERATURE**

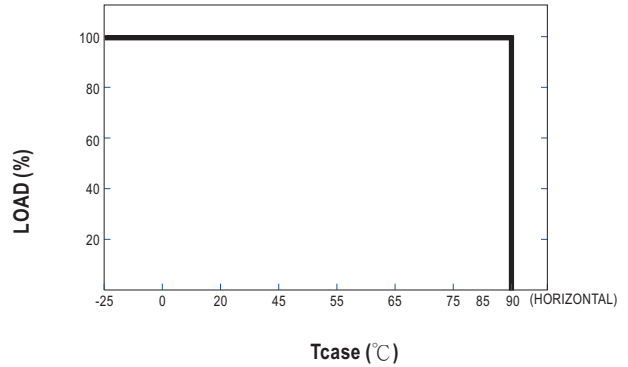
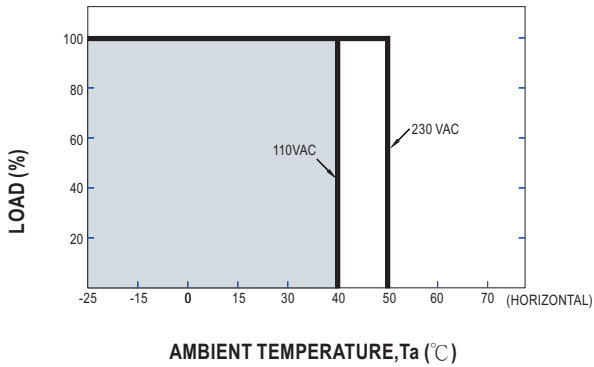

■ **STATIC CHARACTERISTIC**

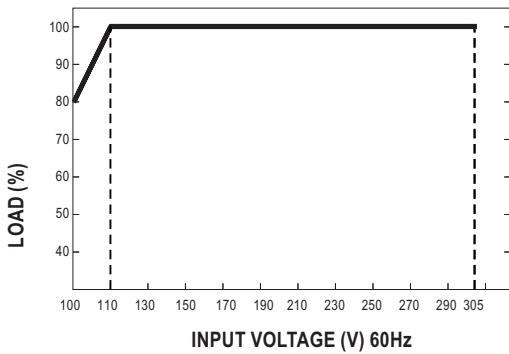

※ De-rating is needed under low input voltage.

■ **LIFE TIME**

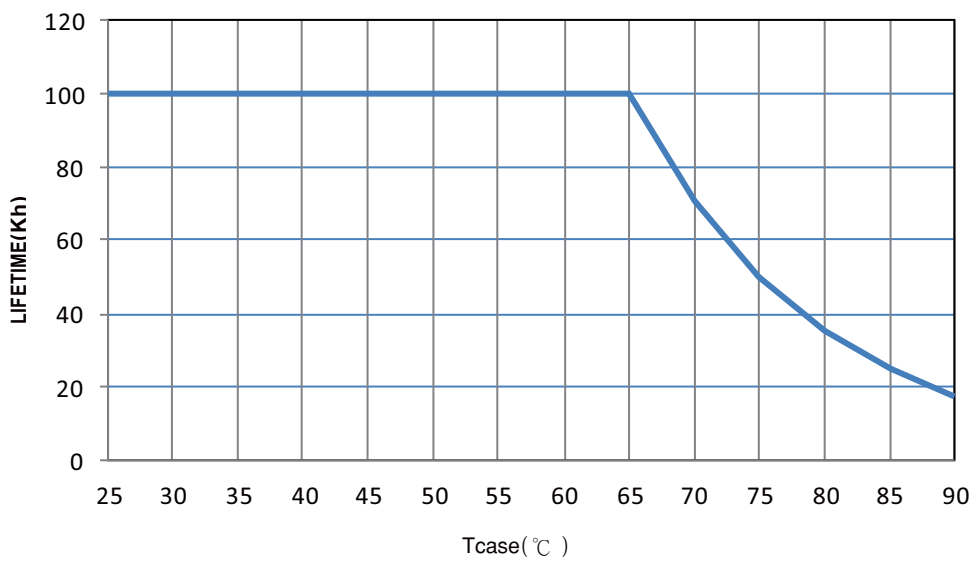

TOTAL HARMONIC DISTORTION (THD)

※ XLN-40-H Model, Tcase at 75°C

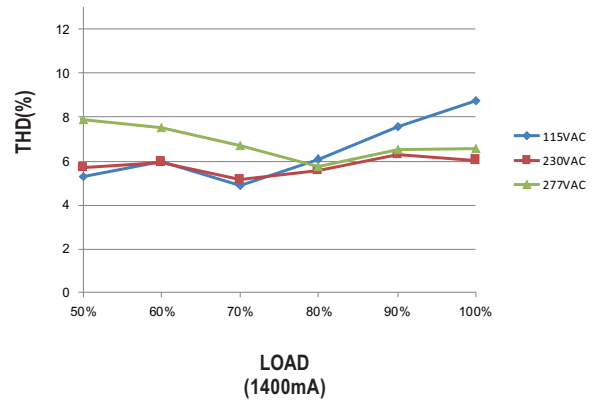
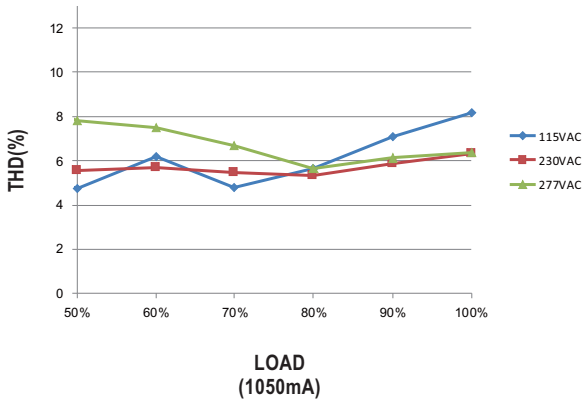

POWER FACTOR (PF) CHARACTERISTIC

※ XLN-40-H Model, Tcase at 75°C

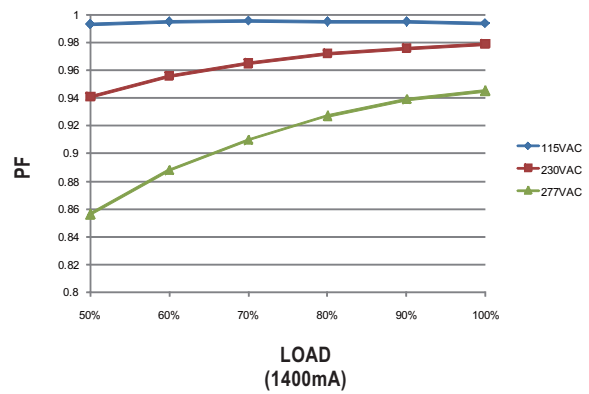
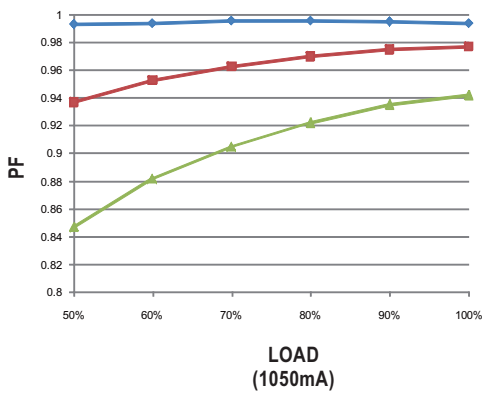

EFFICIENCY vs LOAD

XLN-40 series possess superior working efficiency that up to 88% can be reached in field applications.

※ XLN-40-H Model, Tcase at 75°C

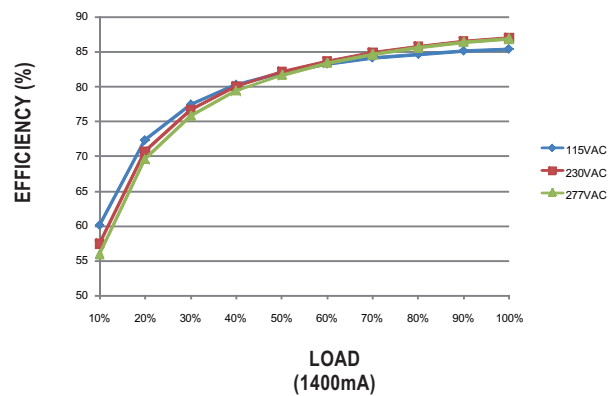
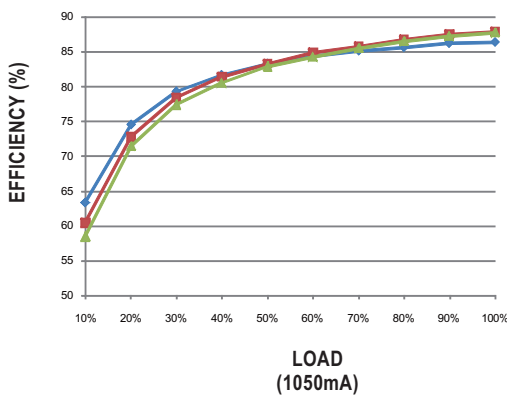

MECHANICAL SPECIFICATION

Case No. XLN-25 Unit: mm Tolerance: ±1

※ Blank type

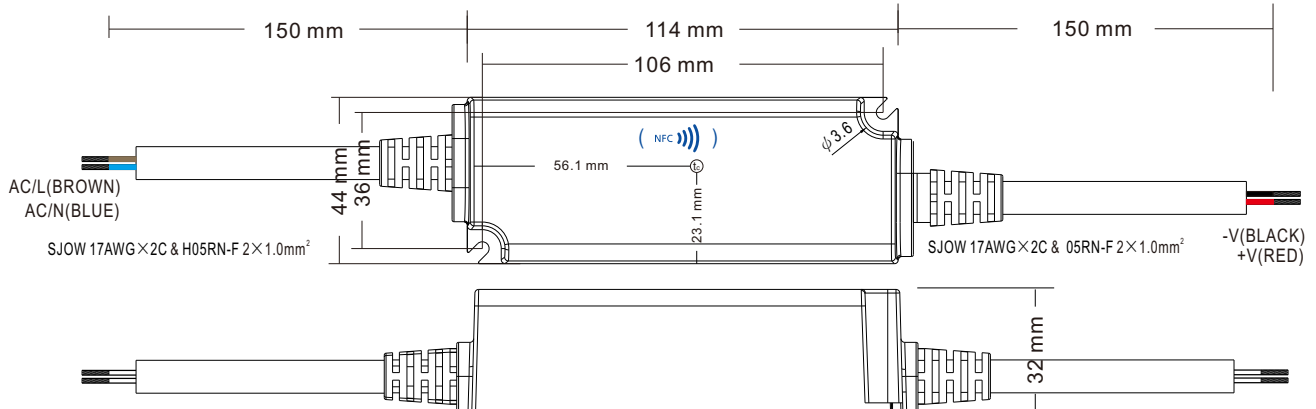

※ B type

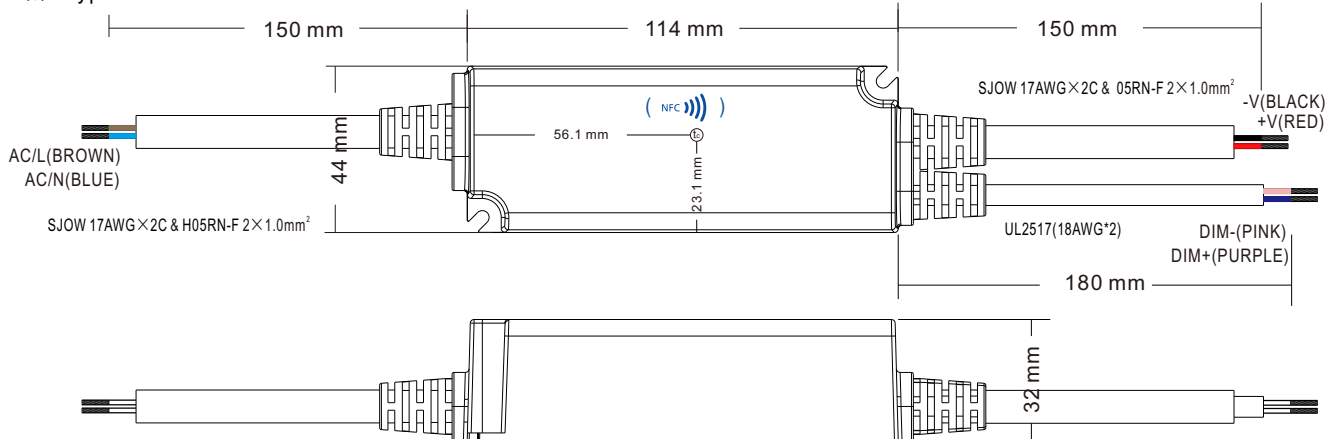

※ DA2 type

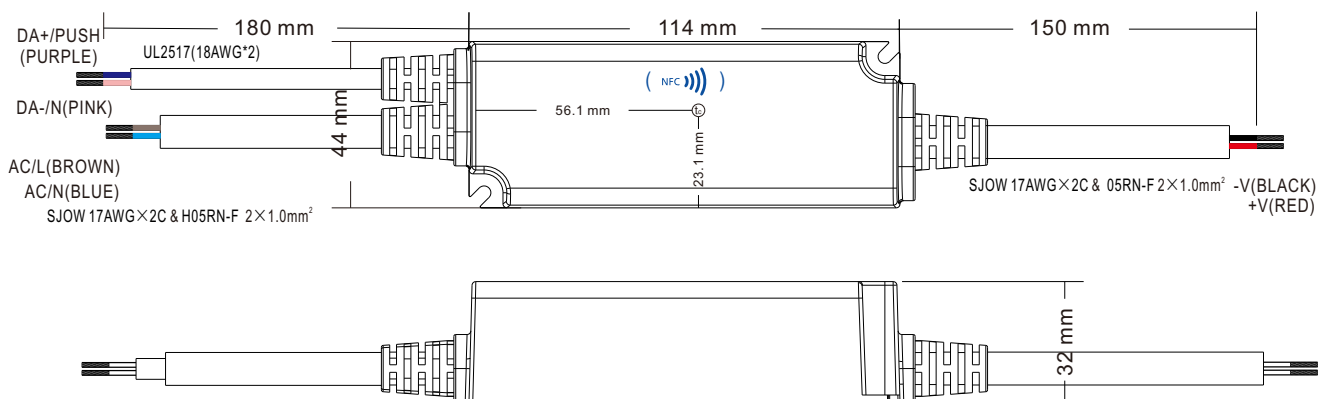

Installation Manual

Please refer to : <http://www.meanwell.com/manual.html>

 www.simpex.ch

Besuchen Sie unseren Simpex E-Shop mit über 12'000 Produkten.

Er bietet Ihnen eine breite Funktionsvielfalt, sowie intelligente Suchfunktionen. Ob Sie den Shop als Einkaufsplattform oder als Produktfinder nutzen – im Simpex E-Shop haben Sie alle Informationen schnell und tagesaktuell zur Hand.

24h und das 365 Tage im Jahr.



Hauptsitz

Simpex Electronic AG
Binzackerstrasse 33
CH-8620 Wetzikon
Telefon +41 44 931 10 10
E-Mail contact@simpex.ch
Internet www.simpex.ch