



(XDR-120-xx)



(XDR-120-xxLA)



(XDR-120-xxPI)



## Applications

## Features

- 85~305Vac input with PFC (277Vac available)
- Global certificates in multi-fields(ITE 62368-1, Industrial 61558-1/-2-16,61010) & Marine DNV, SEMI47, CID2 HazLoc approved
- 30mm ultra slim width
- High efficiency up to 94% and no load power dissipation 0.9W~1W by R.C.
- 200% peak power capability
- 600% transient peak current capability
- Built-in constant current limiting circuit
- Protections: Short circuit / Overload / Over voltage / Over temperature
- Fanless design, cooling by free air convection
- Over voltage category III (OVC III)
- -40~+85°C wide range operation temperature(>+60°C derating)
- Operating altitude up to 5000 meters
- Built-in remote ON/OFF control and DC OK relay contact
- Ultra low inrush current <6~15A
- Built-in ORing FET
- Tool free terminal block (LA Type)
- Conformal coating
- Can be installed on DIN rail TS-35/75 or 15
- 5 years warranty

- Industrial control system
- Semiconductor fabrication equipment
- Factory automation
- Electro-mechanical apparatus

## GTIN CODE



MW Search: <https://www.meanwell.com/serviceGTIN.aspx>

## Description

The XDR-120 series is a 120W AC/DC high-end ultra slim industrial DIN rail power. Key features of this series include a narrow 30mm casing, optimizing system installation space, and an ultra-wide input range of 85~305Vac suitable for global use. It boasts a maximum efficiency of 94% and a low standby power consumption of 0.9W~1W for energy savings and carbon reduction. It provides constant current with up to 200% peak power, and can handle instantaneous peak current of 600%. It has a fanless design, ultra-wide operating temperature range of -40 to +85°C (up to +60°C at full load); OVCIII compliance; ultra-low inrush current of <6~15A, and includes DC OK and remote ON/OFF functions. It also has a built-in ORing FET, the internal PCB has a coating for basic moisture and dust protection, and it has multiple terminal blocks for selection. With comprehensive protection functions, complete safety certifications, and a 5-years warranty, the XDR-120 series is a compact, high-performance, and highly reliable DIN rail power supply.

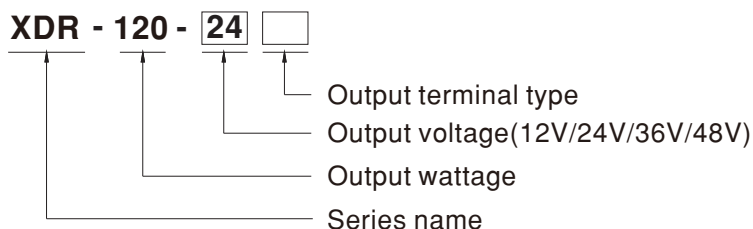
## Model Encoding



Terminal Type Options		Note
Blank	Screw Terminal 	In stock
LA	Lever Actuated 	In stock
PI	Push In 	In stock

SPECIFICATION		XDR-120-12 <input type="checkbox"/>	XDR-120-24 <input type="checkbox"/>	XDR-120-36 <input type="checkbox"/>	XDR-120-48 <input type="checkbox"/>
		□ =Blank, LA, PI			
<b>OUTPUT</b>					
DC VOLTAGE		12V	24V	36V	48V
LOAD CURRENT RANGE		0 ~ 10A	0 ~ 5A	0 ~ 3.33A	0 ~ 2.5A
RATED POWER		120W	120W	119.88W	120W
PEAK	CURRENT (5sec.)	20A	10A	6.66A	5A
	POWER (5sec.)	240W	240W	239.76W	240W
RIPPLE & NOISE (max.)	Note.2	100mVp-p	100mVp-p	120mVp-p	120mVp-p
VOLTAGE ADJ. RANGE		12 ~ 15V	24 ~ 29V	36 ~ 42V	48 ~ 55V
VOLTAGE TOLERANCE	Note.3	±1.0%	±1.0%	±1.0%	±1.0%
LINE REGULATION		±0.5%	±0.5%	±0.5%	±0.5%
LOAD REGULATION		±1.0%	±1.0%	±1.0%	±1.0%
SETUP, RISE TIME		1500ms, 60ms/230Vac    3000ms, 60ms/115Vac at full load			
HOLD UP TIME (Typ.)		20ms/230Vac    20ms/115Vac at full load			
<b>INPUT</b>					
AC VOLTAGE RANGE		85 ~ 305Vac			
DC VOLTAGE RANGE		80 ~ 431Vdc (Derating 50% Load @80Vdc)			
NO LOAD CONSUMPTION(Typ.)	Remote Power OFF	0.9W@115Vac & 230Vac	1W@115Vac & 230Vac		
	Remote Power ON	2W@115Vac & 230Vac			
FREQUENCY RANGE		47 ~ 63Hz			
POWER FACTOR (Typ.)		PF>0.98/115Vac	PF>0.95/230Vac	PF>0.9/277Vac at full load	
EFFICIENCY (Typ.)		93.5%	94%	94%	94%
AC CURRENT (Typ.)		2.3A/115Vac	1.2A/230Vac		
INRUSH CURRENT (Typ.)		COLD START	6A/115Vac	10A/230Vac	15A/277Vac
LEAKAGE CURRENT		<1mA/ 240Vac    <1.5mA/ 277Vac			
<b>PROTECTION</b>					
OVERLOAD		105%~200% rated output power for more than 5 sec then constant current limiting at rate current without shutdown when Vo=30%~100% ; Hiccup mode when Vo<30% rated voltage			
OVER VOLTAGE		16 ~ 19V	30 ~ 34V	43 ~ 50V	57 ~ 65V
Protection type : Shut down o/p voltage, re-power on to recover					
OVER TEMPERATURE		Protection type : Shut down o/p voltage, recovers automatically after temperature goes down			
<b>FUNCTION</b>					
DC OK RELAY CONTACT		Relay Contact Ratings (max.):30Vdc/1A, 30Vac/0.5A resistive load			
REMOTE CONTROL		Power ON :RC + ~ RC- keep <0.8Vdc or open			
		Power OFF:RC + ~ RC- keep 3.3~5Vdc by external voltage			
TRANSIENT PEAK CURRENT CAPABILITY		12V:600% rated current for 4ms;    24V/36V/48V:600% rated current for 10ms			
<b>ENVIRONMENT</b>					
WORKING TEMP.		-40 ~ +85°C (Refer to "Derating Curve")			
WORKING HUMIDITY		20 ~ 95% RH non-condensing			
STORAGE TEMP., HUMIDITY		-40 ~ +85°C, 10 ~ 95% RH non-condensing			
TEMP. COEFFICIENT		±0.03%/°C (0 ~ 60°C) on Load output			
VIBRATION		Component:10 ~ 500Hz, 2G 10min./1cycle, 60min. each along X, Y, Z axes; Mounting: Compliance to IEC60068-2-6			

SPECIFICATION	XDR-120-12 <input type="checkbox"/>	XDR-120-24 <input type="checkbox"/>	XDR-120-36 <input type="checkbox"/>	XDR-120-48 <input type="checkbox"/>
	<input type="checkbox"/> =Blank, LA, PI			
<b>SAFETY &amp; EMC</b> <span style="float:right">Note.4&amp;5&amp;6</span>				
<b>SAFETY STANDARDS</b>	CB IEC62368-1, IEC61558-1/2-16, IEC61010-1/2-201 TUV BS EN/EN62368-1, BS EN/EN61558-1/2-16, BS EN/EN61010-1/2-201 UL <a href="#">UL121201/CSA C22.2 NO.213.17 Class I, DIV2 Group A,B,C,D Hazardous Locations T4</a> ; UL61010-1/2-201 CCC GB4943.1 BSMI CNS15598-1 EAC TPTC004 Marine DNV SEMI F47 approved KC/BIS <a href="#">KC62368-1</a> and <a href="#">BIS IS 13252 (Part 1)</a> certified, no stock by request ,contact sales for inquires			
<b>OVER VOLTAGE CATEGORY</b>	Note.7 IEC/EN 61558-1/2-16 (OVC III, altitude up to 2000m ) IEC/EN/UL 61010-1/2-201 (OVC II, altitude up to 5000m ) IEC/EN 62368-1 (OVC II, altitude up to 5000m )			
<b>SAFETY EXTRA-LOW VOLTAGE(SELV)</b>	IEC/EN 61558-2-16 (SELV) IEC/EN 62368-1 (SELV / ES1 )			
<b>WITHSTAND VOLTAGE</b>	I/P-O/P: 4KVac I/P-FG: 2KVac O/P-FG: 1.5KVac O/P-DC OK: 0.5KVac			
<b>ISOLATION RESISTANCE</b>	I/P-O/P, I/P-FG, O/P-FG: 100M Ohms/500VDC/25°C / 70%RH			
<b>EMC EMISSION</b>	<b>Parameter</b>	<b>Standard</b>	<b>Test Level / Note</b>	
	Conducted	BS EN/EN55032 (CISPR32) / BS EN/EN61204-3 / CNS15936 / KS C 9832	Class B	
	Radiated	BS EN/EN55032 (CISPR32) / BS EN/EN61204-3 / CNS15936 / KS C 9832	Class B	
	Harmonic Current	BS EN/EN61000-3-2	Class A	
	Voltage Flicker	BS EN/EN61000-3-3	-----	
<b>EMC IMMUNITY</b>	BS EN/EN55035 , BS EN/EN61204-3, BS EN/EN61000-6-2(BS EN/EN50082-2) ,KS C 9835, SEMI F47 tested at 200Vac			
	<b>Parameter</b>	<b>Standard</b>	<b>Test Level / Note</b>	
	ESD	BS EN/EN61000-4-2	Level 4, 15KV air ; Level 4, 8KV contact; criteria A	
	Radiated	BS EN/EN61000-4-3	Level 3, 10V/m ; criteria A	
	EFT / Burst	BS EN/EN61000-4-4	Level 4, 4KV ; criteria A	
	Surge	BS EN/EN61000-4-5	Level 4, 2KV/Line-Line ; Level 4, 4KV/Line-Line-Chassis ; criteria A	
	Conducted	BS EN/EN61000-4-6	Level 3, 10V ; criteria A	
Magnetic Field	BS EN/EN61000-4-8	Level 4, 30A/m ; criteria A		
<b>OTHERS</b>				
<b>MTBF</b>	1550.7K hrs min. Telcordia SR-332 (Bellcore); 246.3K hrs min. MIL-HDBK-217F (25°C)			
<b>DIMENSION</b>	30*125.2*116mm (W*H*D)			
<b>PACKING</b>	0.595Kg; 20pcs/ 12.9Kg / 1.27CUFT			
<b>NOTE</b>				
1. All parameters NOT specially mentioned are measured at 230Vac input, rated load and 25°C of ambient temperature. 2. Ripple & noise are measured at 20MHz of bandwidth by using a 12" twisted pair-wire terminated with a 0.1 μ F & 47 μ F parallel capacitor. 3. Tolerance : includes set up tolerance, line regulation and load regulation. 4. The power supply is considered a component which will be installed into a final equipment. The final equipment must be re-confirmed that it still meets EMC directives. (as available on <a href="https://www.meanwell.com/Upload/PDF/EMI_statement_en.pdf">https://www.meanwell.com/Upload/PDF/EMI_statement_en.pdf</a> ) 5. The Regulatory Compliance Mark (RCM) is applied on a voluntary basis. The equipment meets the relevant IEC or AS/NZS standards, or AS/NZS 3820 where applicable. The use of the RCM mark complies with AS/NZS 4417.1. 6. Some factory or model may not have the BIS logo, please contact your MEAN WELL sales for more information. 7. The ambient temperature derating of 3.5°C/1000m with fanless models and of 5°C/1000m with fan models for operating altitude higher than 2000m(6500ft). 8. Installation clearances : 40mm on top, 20mm on the bottom, 5mm on the left and right side are recommended when loaded permanently with full power. In case the adjacent device is a heat source, 15mm clearance is recommended. ※ Product Liability Disclaimer : For detailed information, please refer to <a href="https://www.meanwell.com/serviceDisclaimer.aspx">https://www.meanwell.com/serviceDisclaimer.aspx</a>				

## Block Diagram

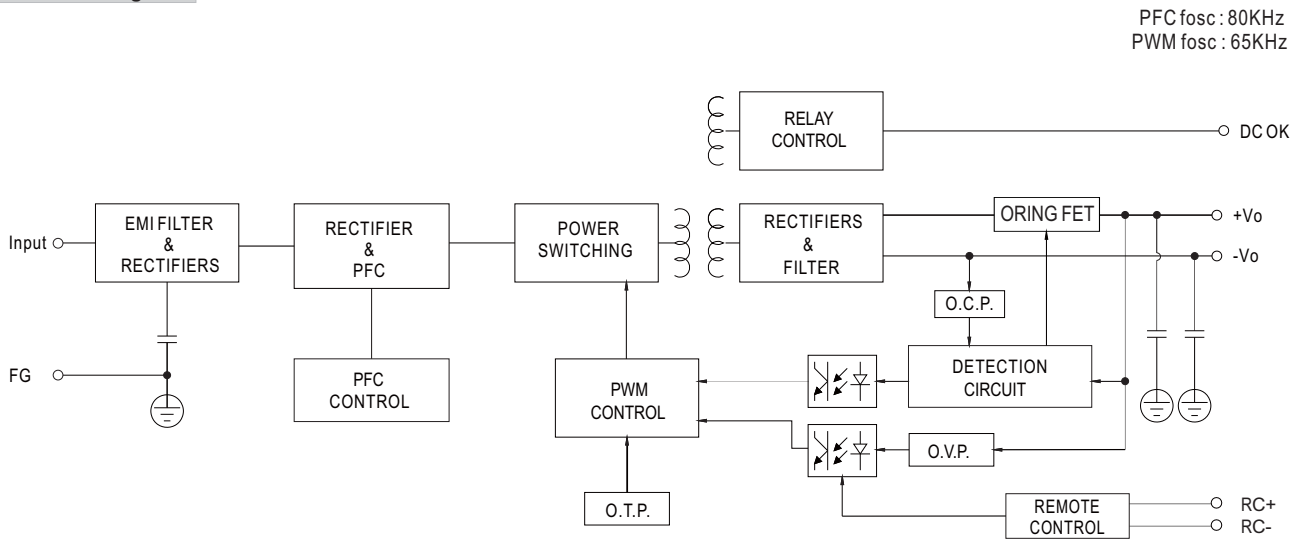

## Derating Curve

Suitable for 100/110/115/120Vac System (85~132Vac)

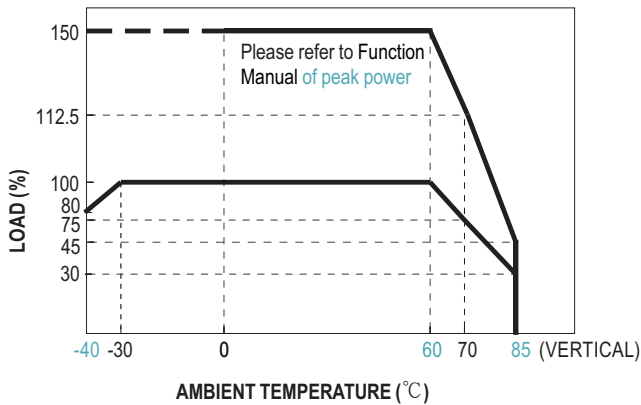

Suitable for 220/230/240/277Vac System (180~305Vac)

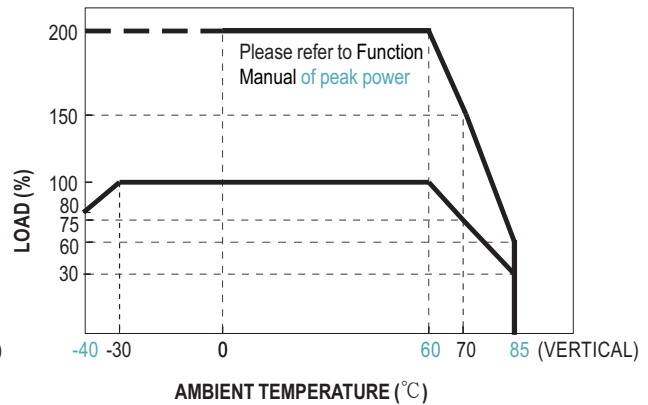

## Output derating VS input voltage

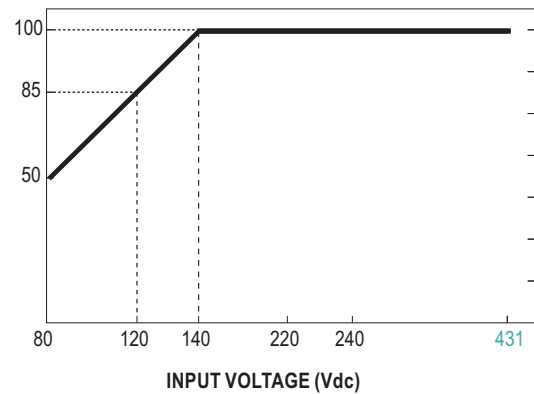
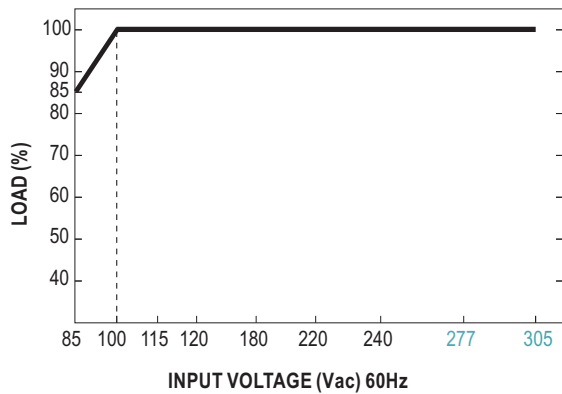

## Peak Power

$$P_{av} = \frac{P_{pk} \times t + P_{npk} \times (T-t)}{T} \leq P_{rated}$$

$$Duty = \frac{t}{T} \times 100\% \leq 35\%$$

$$t \leq 5 \text{ sec}$$

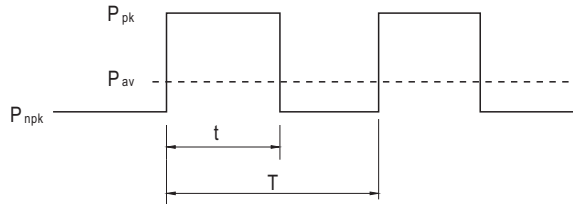

$P_{av}$  : Average output power (W)

$P_{pk}$  : Peak output power (W)

$P_{npk}$  : Non-peak output power (W)

$P_{rated}$  : Rated output power (W)

$t$  : Peak power width (sec)

$T$  : Period (sec)

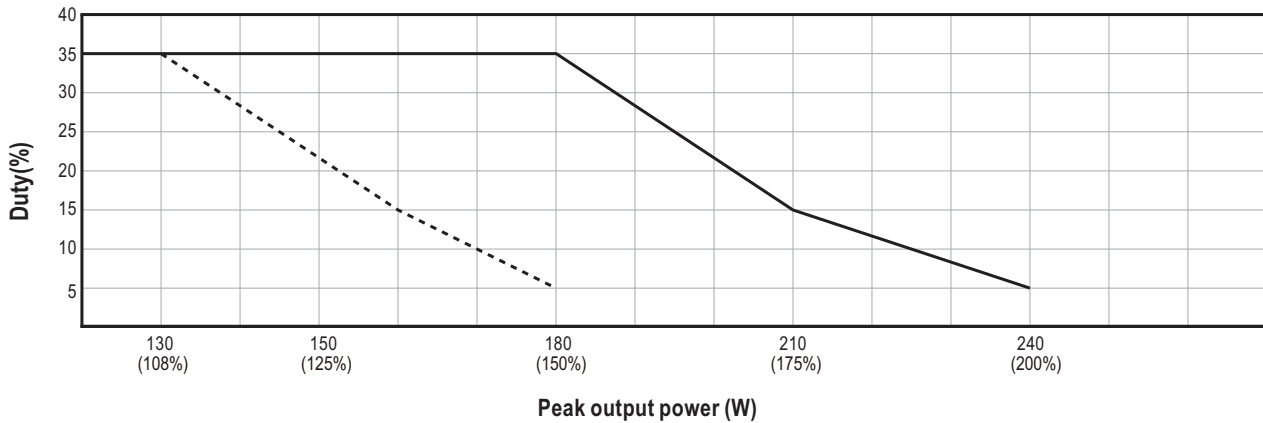
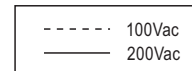

### For example (24V model) :

$V_{in} = 200Vac$      $Duty_{max} = 5\%$

$P_{av} = P_{rated} = 120W$

$P_{pk} = 240W$

$t \leq 5 \text{ sec}$

$$T \geq \frac{5 \text{ sec}}{5\%} \geq 100 \text{ sec}$$

$$P_{npk} \leq \frac{T P_{av} - t P_{pk}}{T-t}$$

$$P_{npk} \leq 113.7W$$

## Transient peak current Capability

The device can deliver peak currents (up to several milliseconds) which are higher than the specified short term currents.

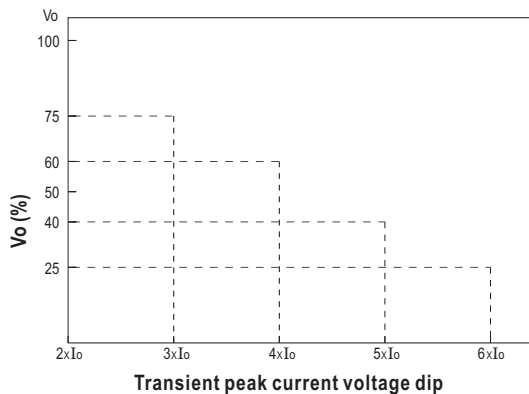

Load	Vo(%)	12V	24V/36V/48V
		Time	Time
3xIo	75	15ms	35ms
4xIo	60	8ms	17ms
5xIo	40	5ms	13ms
6xIo	25	4ms	10ms

Note: The 4ms~35ms in the table must be after AC mains is turned on.

■ Function Manual

Pin No.	Function	Description
1,2	DC OK Relay Contact	Contact close : PSU turns ON/DC_OK ; Contact open : PSU turns OFF/DC_fail; Contact ratings (max.): 30Vdc/1A ,30Vac/0.5A resistive load.
3	RC+	Turns the output ON and OFF by electrical signal Remote power ON : Keep <0.8Vdc or open Remote power OFF: Keep 3.3~5Vdc by external voltage
4	RC-	

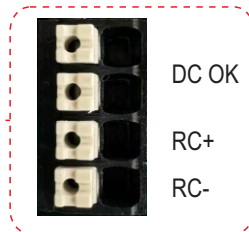
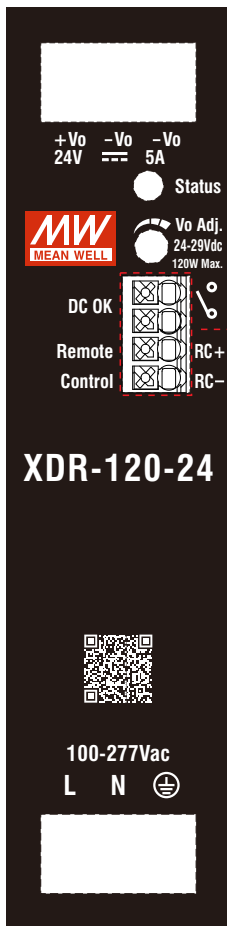

## 1. DC OK Relay Contact

Contact Close	PSU turns ON / DC OK.
Contact Open	PSU turns OFF / DC Fail.
Contact Ratings (max.)	30Vdc/1A, 30Vac/0.5A resistive load.

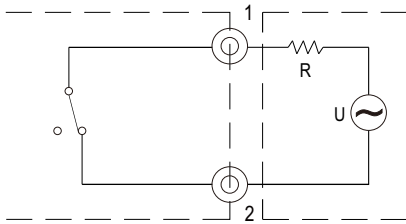
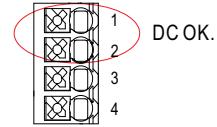

External voltage source (U) and resistor (R)  
(The max. Sink is 30Vdc/1A, 30Vac/0.5A)

Internal circuit of DC\_OK, via relay contact

## 2. Remote ON/OFF Control

The PSU can be turned ON/OFF by using the "Remote Control" function.

PSU Vo Status	Between RC+(Pin3) and RC-(Pin 4)
Remote power ON	Keep <0.8Vdc or open
Remote power OFF	Keep 3.3~5Vdc by external voltage

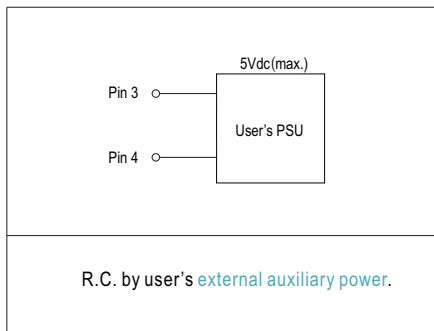
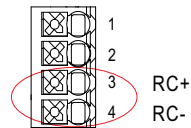

## 3. Protection Against Inverse Voltages From The Load

Prevent PSU damage from Back Electro magnetic Force during deceleration of motor or inductive load.

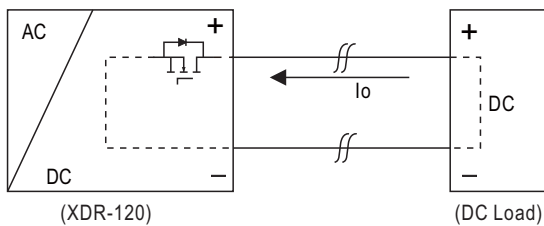

PSU'S ORing FET turn OFF voltage	
MODEL	Max. allowable reverse voltage
XDR-120-12	<16V
XDR-120-24	<35V
XDR-120-36	<50V
XDR-120-48	<63V

## ■ Mechanical Specification

(Unit:mm , Tolerance  $\pm 1$ mm)

Case No.301

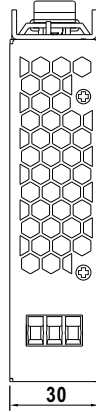

Ⓐ : Terminal Pin No.Assignment

Pin No.	Assignment
1	DC Output +Vo
2,3	DC Output -Vo

Ⓑ : Control Pin No.Assignment

Pin No.	Assignment
1,2	DC OK Relay Contact
3	RC+
4	RC-

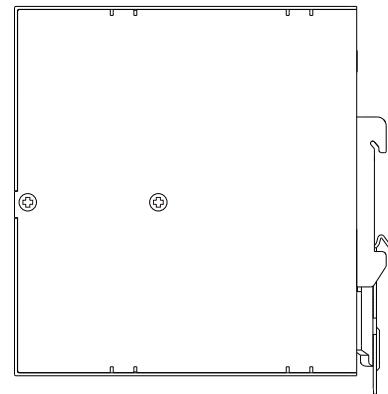
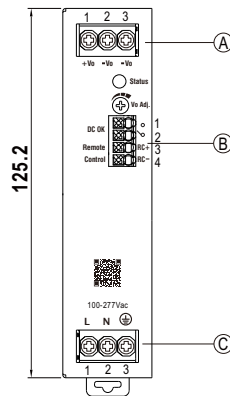
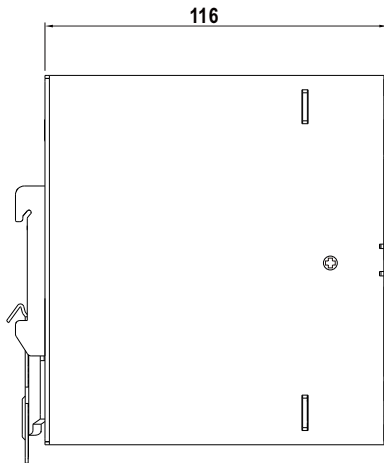

Ⓒ : Terminal Pin No.Assignment

Pin No.	Assignment
1	AC/L or DC Input +Vin
2	AC/N or DC Input -Vin
3	FG $\oplus$

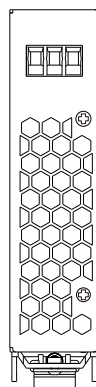

**Recommend Wiring**

		AC Input T.B	DC Output T.B	Signal connector
Solid Wire		6mm <sup>2</sup> max.	6mm <sup>2</sup> max.	1.5mm <sup>2</sup> max.
A.W.G		16~10 AWG	16~10 AWG	24~16 AWG
Wire Stripping Length	Blank	10~11mm	10~11mm	8~9mm
	LA	11~12mm	11~12mm	
	PI	14~15mm	14~15mm	
Screw Terminal Torque	Blank	5 Lb-In	5 Lb-In	/
	LA/PI	Not applicable		

**Installation Instruction**

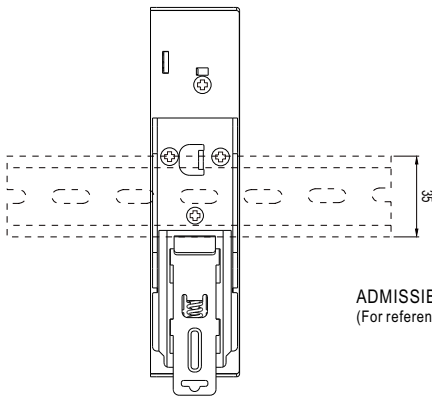

This series fits DIN rail TS35/7.5 or TS35/15.  
For installation details, please refer to the Instruction manual.

ADMISSIBLE DIN-RAIL: TS35/7.5 OR TS35/15  
(For reference only. Not included with unit.)

**Installation Manual**

Please refer to : <http://www.meanwell.com/manual.html>

 [www.simpex.ch](http://www.simpex.ch)

Besuchen Sie unseren Simpex E-Shop mit über 12'000 Produkten.

Er bietet Ihnen eine breite Funktionsvielfalt, sowie intelligente Suchfunktionen. Ob Sie den Shop als Einkaufsplattform oder als Produktfinder nutzen – im Simpex E-Shop haben Sie alle Informationen schnell und tagesaktuell zur Hand.

24h und das 365 Tage im Jahr.



## Hauptsitz

**Simpex Electronic AG**  
Binzackerstrasse 33  
CH-8620 Wetzikon  
Telefon +41 44 931 10 10  
E-Mail [contact@simpex.ch](mailto:contact@simpex.ch)  
Internet [www.simpex.ch](http://www.simpex.ch)