

ANSI/AAMI ES60601-1 BS EN/EN60601-1 IEC60601-1 TPTC004

## ■ Features

- 4"×2" compact size
- Medical safety approved (2 x MOPP) according to ANSI/AAMI ES60601-1 and IEC/BS EN/EN60601-1
- Suitable for BF application with appropriate system consideration
- 84W convention, 120W force air
- EMI Class B for both Class I (with FG) & Class II (no FG) configuration
- No load power consumption < 0.3W
- Extremely low leakage current
- 12V/0.5A fan supply
- Protections: Short circuit / Overload / Over voltage / Over temperature
- Operating altitude up to 4000 meters
- 3 years warranty

## ■ Applications

- Oral irrigator
- Hemodialysis machine
- Medical monitors
- Sleep apnea devices
- Pumps machine

## ■ GTIN CODE

MW Search: <https://www.meanwell.com/serviceGTIN.aspx>

## ■ Description

RPS-120 is a 120W highly reliable green PCB type medical power supply with a high power density on a 4" by 2" footprint. It accepts 80~264VAC input and offers various models with the output voltages between 12V and 48V. The working efficiency is up to 91% and the extremely low no load power consumption is down below 0.3W. RPS-120 is able to be used for both Class I (with FG) or Class II (no FG) system design. The extremely low leakage current is less than 190  $\mu$ A. In addition, it conforms to the international medical regulations (2\*MOPP) and EMC BS EN/EN55011, perfectly fitting all kinds of BF rated "patient contact" medical system equipment.

## ■ Model Encoding

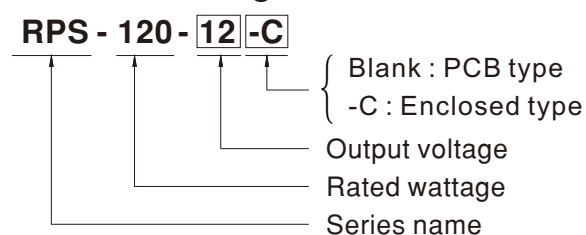

**SPECIFICATION**

MODEL		RPS-120-12□	RPS-120-15□	RPS-120-24□	RPS-120-27□	RPS-120-48□	
OUTPUT	DC VOLTAGE	12V	15V	24V	27V	48V	
	CURRENT	10CFM	10A	8A	5A	4.5A	2.5A
		Convection	7.0A	5.6A	3.5A	3.15A	1.75A
	RATED POWER	10CFM	120W	120W	120W	121.5W	120W
		Convection	84W	84W	84W	85W	84W
	RIPPLE & NOISE (max.) Note.2	100mVp-p	120mVp-p	150mVp-p	150mVp-p	150mVp-p	
	VOLTAGE ADJ. RANGE	11.4~12.6V	14.3~15.8V	22.8~25.2V	25.6~28.4V	45.6~50.4V	
	VOLTAGE TOLERANCE Note.3	±2.0%	±2.0%	±1.0%	±1.0%	±1.0%	
	LINE REGULATION	±0.5%	±0.5%	±0.5%	±0.5%	±0.5%	
	LOAD REGULATION	±1.0%	±1.0%	±1.0%	±1.0%	±1.0%	
SETUP, RISE TIME	500ms, 30ms/230VAC      500ms, 30ms/115VAC at full load						
HOLD UP TIME (Typ.)	50ms/230VAC      10ms/115VAC at full load						
INPUT	VOLTAGE RANGE Note.4	80 ~ 264VAC      113 ~ 370VDC					
	FREQUENCY RANGE	47 ~ 63Hz					
	EFFICIENCY (Typ.)	89%	89%	90%	90%	91%	
	AC CURRENT (Typ.)	2.1A/115VAC      1.2A/230VAC					
	INRUSH CURRENT (Typ.)	COLD START 30A/115VAC      60A/230VAC					
	LEAKAGE CURRENT(max.) Note.5	Earth leakage current < 190μA/264VAC , Touch current < 100μA/264VAC					
PROTECTION	OVERLOAD	115~150% rated output power Protection type : Hiccup mode, recovers automatically after fault condition is removed					
	OVER VOLTAGE	13.2 ~ 15.6V	16.5 ~ 19.5V	26.4 ~ 31.2V	29.7 ~ 35V	52.8 ~ 62.4V	
	OVER TEMPERATURE	Protection type : Shut down o/p voltage, re-power on to recover					
FUNCTION	FAN SUPPLY	12V@0.5A for driving a fan ; tolerance -15% ~ +10% at main output 40% rated current (10CFM)					
ENVIRONMENT	WORKING TEMP.	-30 ~ +70°C (Refer to "Derating Curve")					
	WORKING HUMIDITY	20 ~ 90% RH non-condensing					
	STORAGE TEMP., HUMIDITY	-40 ~ +85°C, 10 ~ 95% RH non-condensing					
	TEMP. COEFFICIENT	±0.03%/°C (0 ~ 50°C)					
	VIBRATION	10 ~ 500Hz, 2G 10min./1cycle, 60min. each along X, Y, Z axes					
	OPERATING ALTITUDE Note.6	4000 meters					
SAFETY & EMC (Note 7)	SAFETY STANDARDS	IEC 60601-1:2005+A1+A2, TUV BS EN/ EN 60601-1:2006+A1+A12+A2, ANSI/AAMI ES60601-1:2005+A2 CAN/CSA C22.2 No. 60601-1:2014+A2, EAC TP TC 004 approved; Design refer to BS EN/EN60335-1(by request)					
	ISOLATION RESISTANCE	Primary-Secondary: 2xMOPP, Primary-Earth: 1xMOPP, Secondary-Earth: 1xMOPP					
	WITHSTAND VOLTAGE	I/P-O/P:4KVAC    I/P-FG:2KVAC    O/P-FG:1.5KVAC					
	ISOLATION RESISTANCE	I/P-O/P, I/P-FG:100M Ohms / 500VDC / 25°C / 70% RH					
	EMC EMISSION	Parameter		Standard		Test Level / Note	
		Conducted emission		BS EN/EN55011 (CISPR11)		Class B	
		Radiated emission		BS EN/EN55011 (CISPR11)		Class B	
		Harmonic current		BS EN/EN61000-3-2		Class A	
		Voltage flicker		BS EN/EN61000-3-3		-----	
	EMC IMMUNITY	BS EN/EN55035,BS EN/EN60601-1-2					
		Parameter		Standard		Test Level / Note	
		ESD		BS EN/EN61000-4-2		Level 4, 15KV air ; Level 4, 8KV contact	
		RF field susceptibility		BS EN/EN61000-4-3		Level 3, 10V/m( 80MHz~2.7GHz ) Table 9, 9~28V/m( 385MHz~5.78GHz )	
		EFT bursts		BS EN/EN61000-4-4		Level 3, 2KV	
Surge susceptibility		BS EN/EN61000-4-5		Level 4, 4KV/Line-FG; 2KV/Line-Line			
Conducted susceptibility		BS EN/EN61000-4-6		Level 3, 10V			
Magnetic field immunity		BS EN/EN61000-4-8		Level 4, 30A/m			
Voltage dip, interruption		BS EN/EN61000-4-11		100% dip 1 periods, 30% dip 25 periods, 100% interruptions 250 periods			
OTHERS	MTBF	3732.9K hrs min.    Telcordia SR-332 (Bellcore) ; 653.6K hrs min.    MIL-HDBK-217F (25°C)					
	DIMENSION (L*W*H)	PCB:101.6*50.8*29mm or 4" * 2" * 1.141" inch ; Enclosed type:103.4*62*40mm or 4.07" * 2.44" * 1.57" inch					
	PACKING	PCB:0.15Kg; 72pcs/11.8Kg/0.84CUFT ; Enclosed type:0.24Kg; 60pcs/15.4Kg/1.06CUFT					
NOTE	<p>1. All parameters NOT specially mentioned are measured at 230VAC input, rated load and 25 of ambient temperature.</p> <p>2. Ripple &amp; noise are measured at 20MHz of bandwidth by using a 12" twisted pair-wire terminated with a 0.1μf &amp; 47μf parallel capacitor.</p> <p>3. Tolerance : includes set up tolerance, line regulation and load regulation.</p> <p>4. Derating may be needed under low input voltages. Please check the derating curve for more details.</p> <p>5. Touch current was measured from primary input to DC output.</p> <p>6. The ambient temperature derating of 3.5°C/1000m with fanless models and of 5°C/1000m with fan models for operating altitude higher than 2000m(6500ft).</p> <p>7. The power supply is considered a component which will be installed into a final equipment. All the EMC tests are been executed by mounting the unit on a 360mm*360mm metal plate with 1mm of thickness. The final equipment must be re-confirmed that it still meets EMC directives. For guidance on how to perform these EMC tests, please refer to "EMI testing of component power supplies." (as available on <a href="https://www.meanwell.com/Upload/PDF/EMI_statement_en.pdf">https://www.meanwell.com/Upload/PDF/EMI_statement_en.pdf</a> )</p> <p>※ Product Liability Disclaimer : For detailed information, please refer to <a href="https://www.meanwell.com/serviceDisclaimer.aspx">https://www.meanwell.com/serviceDisclaimer.aspx</a></p>						

■ Block Diagram

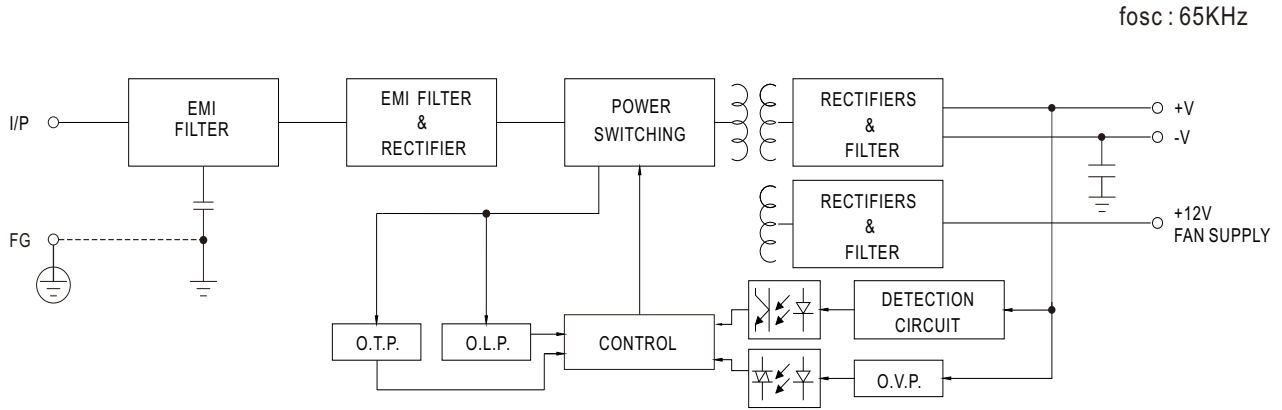

■ Derating Curve

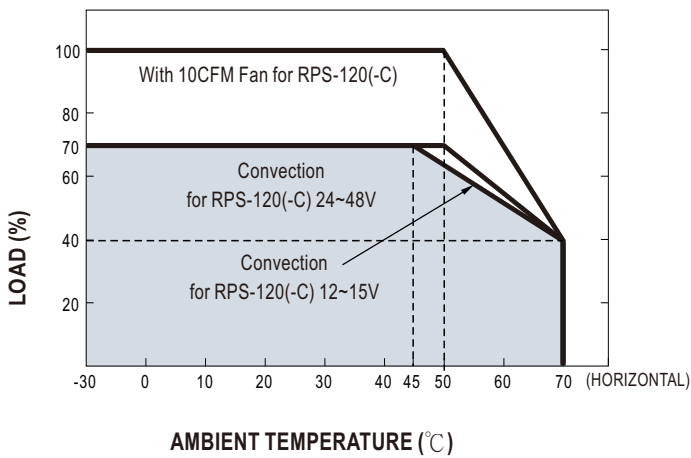

■ Output Derating VS Input Voltage

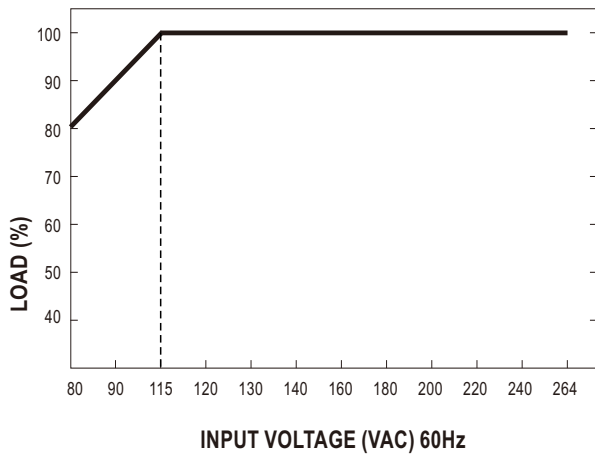

■ Mechanical Specification

(Unit: mm , tolerance  $\pm 1$ mm)

● RPS-120 (PCB Type)

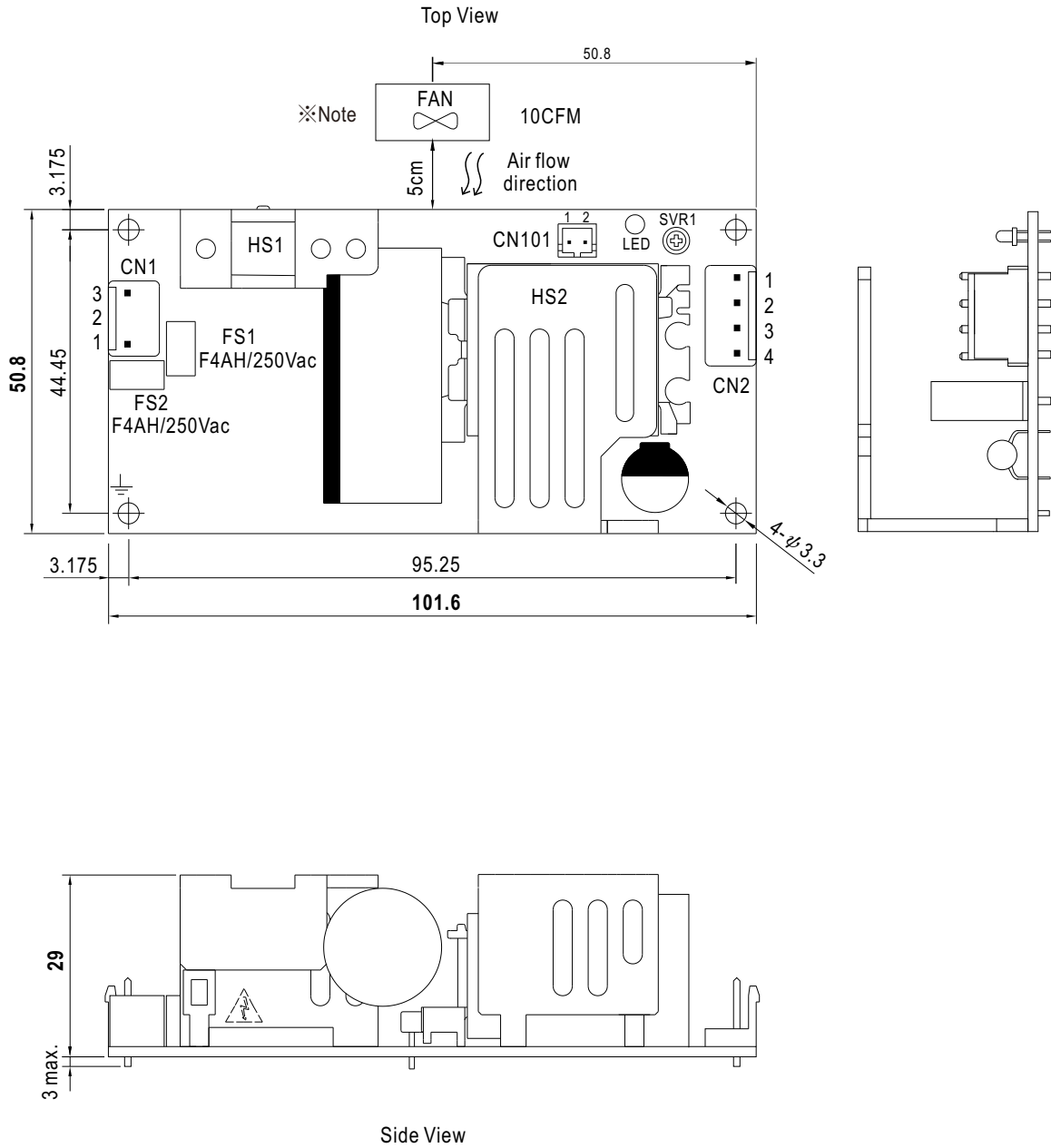

**■ Mechanical Specification**

(Unit: mm , tolerance  $\pm 1$ mm)

Case No.245A

● RPS-120-C (Enclosed Type)

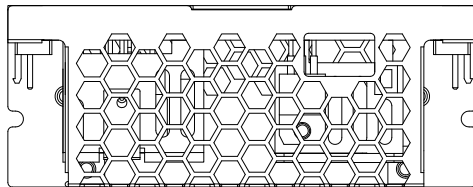
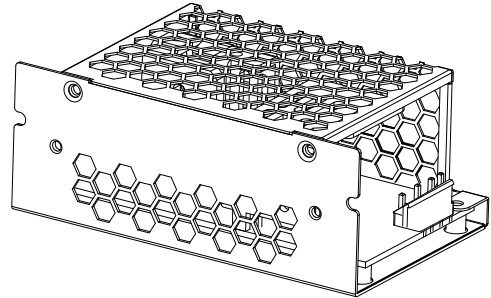

Side View

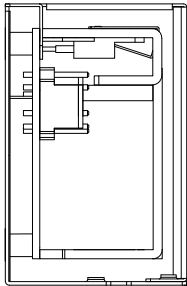

Side View

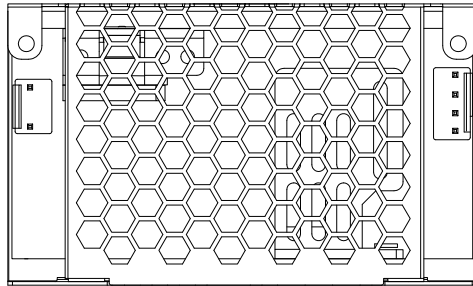

Top View

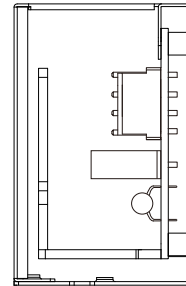

Side View

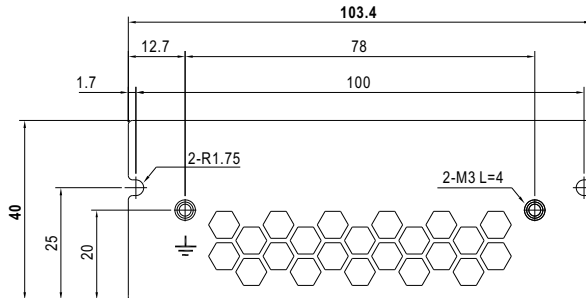

Side View

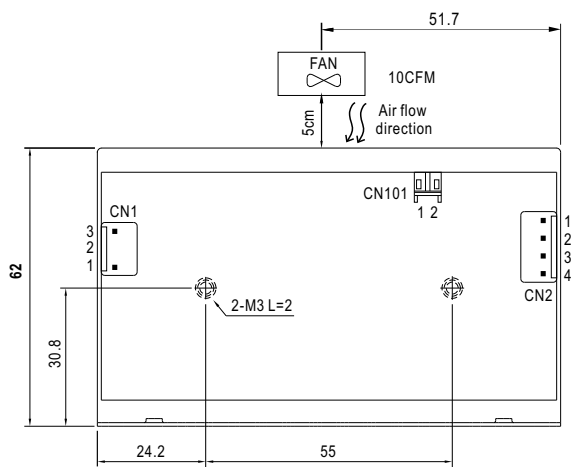

Bottom View

AC Input Connector (CN1) : JST B3P-VH or equivalent

Pin No.	Assignment	Mating Housing	Terminal
1	AC/N	JST VHR or equivalent	JST SVH-21T-P1.1 or equivalent
2	No Pin		
3	AC/L		

DC Output Connector (CN2) : JST B4P-VH or equivalent

Pin No.	Assignment	Mating Housing	Terminal
1,2	+V	JST VHR or equivalent	JST SVH-21T-P1.1 or equivalent
3,4	-V		

FAN Connector(CN101) : JST S2B-PH-K-S or equivalent

Pin No.	Assignment	Mating Housing	Terminal
1	DC COM(FAN-)	JST PHR-2 or equivalent	JST SPH-002T-P0.5S or equivalent
2	+12V(FAN+)		

-  1.HS1,HS2 cannot be shorted.  
2.HS1 must have safety isolation distance with system case.

- ※Note : 1. The FAN supply is designed to serve as the source of the additive external fan for the cooling of the power supply, enabling the full load delivery and assuring the best life span of the product. Please do not use this FAN supply to drive other devices.  
2.The PCB type(Blank type)model delivers EMI Class B for both conducted emission and radiated emission for the power supply, when configured into either Class I (with FG) or Class II (no FG) system.  
3.The Enclosed type(-C type) model is not suitable for the configuration within a Class II (no FG) system but is suggested to used within a Class I (with FG) system.

**■ Installation Manual**

Please refer to : <http://www.meanwell.com/manual.html>

 [www.simpex.ch](http://www.simpex.ch)

Besuchen Sie unseren Simpex E-Shop mit über 12'000 Produkten.

Er bietet Ihnen eine breite Funktionsvielfalt, sowie intelligente Suchfunktionen. Ob Sie den Shop als Einkaufsplattform oder als Produktfinder nutzen – im Simpex E-Shop haben Sie alle Informationen schnell und tagesaktuell zur Hand.

24h und das 365 Tage im Jahr.



## Hauptsitz

**Simpex Electronic AG**  
Binzackerstrasse 33  
CH-8620 Wetzikon  
Telefon +41 44 931 10 10  
E-Mail [contact@simpex.ch](mailto:contact@simpex.ch)  
Internet [www.simpex.ch](http://www.simpex.ch)