

## Forced-air cooling

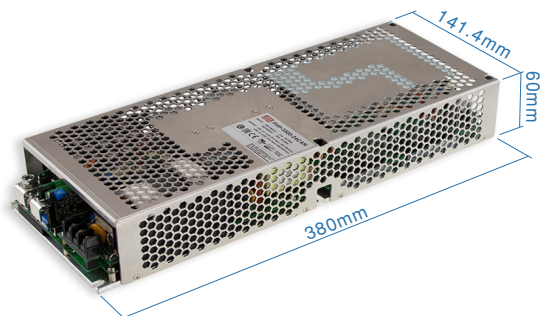

## Water cooling

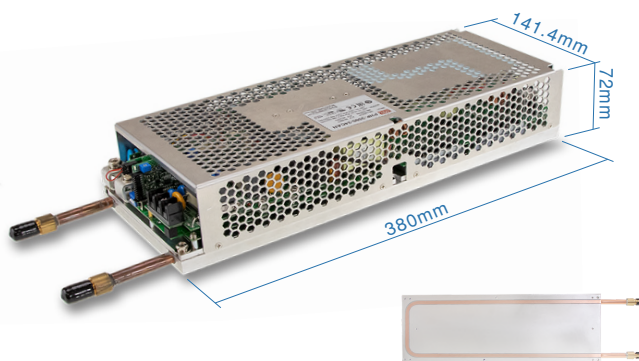

Click Me



Click Me

Ordering No.: PGG1WHS-656  
(Water-Cooling Plate)



## Features

- 90 ~ 264Vac input with PFC
- Slim and Low profile (60mm)
- Fanless design, cooling by water conduction
- Built-in PMBus or CANBus protocol
- Output voltage and constant current level programmable
- Protections: Short circuit / Overload / Over voltage / Over temperature
- -30 ~ +70°C working temperature
- Built-in remote ON-OFF control
- DC OK active signal
- Optional cold plate for quick implementation
- OVCIII Operating altitude up to 3000 meter (Note.9)
- LED indicator for power on
- High efficiency up to 96%
- Active current sharing up to 14000W (3+1)
- 5 years warranty

## Applications

- Industrial automation machinery
- Industrial control system
- Mechanical and electrical equipment
- Electronic instruments, equipments or apparatus
- Household appliances

## GTIN CODE

MW Search: <https://www.meanwell.com/serviceGTIN.aspx>

## Description

PHP-3500 series is a 3500W single-output slim type power supply with 60mm of low profile design. Adopting the full range 90~264Vac input, the entire series provides an output voltage line of 24V and 48V. In addition to the high efficiency up to 96%, that the whole series operates from -30°C ~ +70°C under air convection without fan. PHP-3500 has the complete protection functions and 2G anti-vibration capability; it complies with the international safety regulations such as TUV BS EN/EN62368-1, UL62368-1, and design refers to BS EN/EN61558-1 and BS EN/EN60335-1. PHP-3500 series serves as a high performance power supply solution for various industrial applications.

## Model Encoding

PHP - 3500 - 24

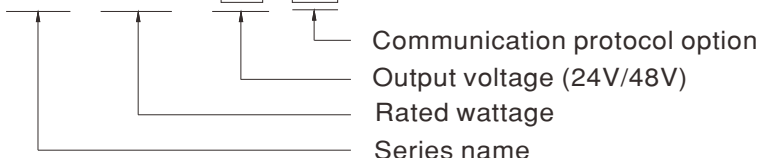

Type	Communication Protocol	Note
Blank	PMBus protocol	In Stock
CAN	CANBus protocol	In Stock

**SPECIFICATION**

MODEL		PHP-3500-24 <input type="checkbox"/>	PHP-3500-48 <input type="checkbox"/>	
OUTPUT	DC VOLTAGE	24V	48V	
	RATED CURRENT	145A	73A	
	RATED POWER	3480W	3504W	
	RIPPLE & NOISE (max.) Note.2	300mVp-p	480mVp-p	
	VOLTAGE ADJ. RANGE	By built-in potentiometer, SVR		
	VOLTAGE TOLERANCE Note.3	±1.0%	±1.0%	
	LINE REGULATION	±0.5%	±0.5%	
	LOAD REGULATION	±0.5%	±0.5%	
	SETUP, RISE TIME Note.4	1500ms, 60ms/230Vac 1500ms, 60ms/115Vac at full load		
	HOLD UP TIME (Typ.) Note.4	16ms/230Vac at 75% load 10ms/230Vac at full load ; 16ms/115Vac at 75% load 10ms/115Vac at full load		
INPUT	VOLTAGE RANGE Note.4	90 ~ 264Vac 127 ~ 370Vdc		
	FREQUENCY RANGE	47 ~ 63Hz		
	POWER FACTOR (Typ.) Note.4	PF ≥ 0.95/230Vac PF ≥ 0.99/115Vdc at full load		
	EFFICIENCY (Typ.) Note.10	95%	96%	
	AC CURRENT (Typ.)	20A/115Vac 20A/230Vac		
	INRUSH CURRENT (Typ.)	Cold start 30A/115Vac 80A/230Vac		
	LEAKAGE CURRENT	2mA / 240Vac		
PROTECTION	OVERLOAD	105 ~ 115% rated current Protection type : Constant current limiting, shut down O/P voltage after 5 sec. After O/P voltage falls, re-power on to recover		
	OVER VOLTAGE	30 ~ 36V	60 ~ 72V	
	OVER TEMPERATURE	Protection type : Shut down O/P voltage, recovers automatically after temperature goes down		
FUNCTION	OUTPUT VOLTAGE PROGRAMMABLE(PV) Note.5,6	Adjustment of output voltage is allowable to 50 ~ 120% of nominal output voltage. Please refer to the Function Manual.		
	OUTPUT CURRENT PROGRAMMABLE(PC) Note.6	Adjustment of constant current level is allowable to 20 ~ 100% of rated current. Please refer to the Function Manual.		
	REMOTE ON/OFF CONTROL	Power ON : Short circuit Power OFF : Open circuit		
	AUXILIARY POWER	12V@0.5A tolerance±10%, ripple 150mVp-p		
	DC-OK SIGNAL	The TTL signal out, PSU turn on = -0.5 ~ 0.5Vdc ; PSU turn off = 3.5 ~ 5.5Vdc. Please refer to the Function Manual.		
ENVIRONMENT	WORKING TEMP.	-30 ~ +70°C Baseplate temperature (Refer to "Derating Curve")		
	WORKING HUMIDITY	20 ~ 90% RH non-condensing		
	STORAGE TEMP., HUMIDITY	-40 ~ +85°C, 10 ~ 95% RH non-condensing		
	TEMP. COEFFICIENT	±0.03%/°C (0 ~ 50°C)		
	VIBRATION	10 ~ 500Hz, 2G 10min./1cycle, 60min. each along X, Y, Z axes		
	OVER VOLTAGE CATEGORY	II ; According to EN61558; altitude up to 5000 meters.		
SAFETY & EMC (Note.8)	SAFETY STANDARDS	UL62368-1, CAN/CSA C22.2 No. 62368-1, TUV BS EN/EN62368-1, EAC TP TC 004 approved ; design refers to BS EN/EN61558-1, BS EN/EN60335-1		
	WITHSTAND VOLTAGE	I/P-O/P:3KVac I/P-FG:2KVac O/P-FG:1.25KVac		
	ISOLATION RESISTANCE	I/P-O/P, I/P-FG, O/P-FG:100M Ohms/500Vdc/25°C / 70%RH		
	EMC EMISSION	Parameter	Standard	Test Level / Note
		Conducted	BS EN/EN55032 (CISPR32)	Class A
		Radiated	BS EN/EN55032 (CISPR32)	Class A
		Harmonic Current	BS EN/EN61000-3-12	-----
		Voltage Flicker	BS EN/EN61000-3-3	-----
	EMC IMMUNITY	Parameter	Standard	Test Level / Note
		ESD	BS EN/EN61000-4-2	Level 3, 8KV air ; Level 2, 4KV contact
		Radiated	BS EN/EN61000-4-3	Level 3
		EFT / Burst	BS EN/EN61000-4-4	Level 3
		Surge	BS EN/EN61000-6-2	2KV/Line-Line 4KV/Line-Earth
		Conducted	BS EN/EN61000-4-6	Level 3
		Magnetic Field	BS EN/EN61000-4-8	Level 4
Voltage Dips and Interruptions		BS EN/EN61000-4-11	>95% dip 0.5 periods, 30% dip 25 periods, >95% interruptions 250 periods	
MTBF		544.8K hrs min. Telcordia SR-332 (Bellcore) ; 56.3K hrs min. MIL-HDBK-217F (25°C)		
DIMENSION	Forced-air cooling: 380*141.4*60mm (L*W*H) Water cooling: 380*141.4*72mm (L*W*H)			
PACKING	4.5Kg; 4pcs/19Kg/2.46CUFT			
NOTE	1. All parameters NOT specially mentioned are measured at 230Vac input, rated load and 25°C of ambient temperature. 2. Ripple & noise are measured at 20MHz of bandwidth by using a 12" twisted pair-wire terminated with a 0.1uf & 47uf parallel capacitor. 3. Tolerance includes set up tolerance, line regulation and load regulation. 4. Derating may be needed under low input voltages. Please check the derating curve and Static characteristics for more details. 5. Without water or fan cooling to provide adequate heat dissipation, OTP might be triggered if trimming output voltage by PV signal toward upper or bottom limits of nominal voltage. Under such condition, enhanced cooling on PSU is highly recommended. 6. PV/PC function when users are not operating on PMBus. SVR functions when users are neither operation on PMBus nor using PV/PC. 7. Output will shut down after O/P voltage is below < 80% of Vset for 5 sec, re-power on to recover. 8. The power supply is considered a component which will be installed into a final equipment. All the EMC tests are been executed by mounting the unit on a 600mm*900mm metal plate with 1mm of thickness. The final equipment must be re-confirmed that it still meets EMC directives. For guidance on how to perform these EMC tests, please refer to "EMI testing of component power supplies." (as available on <a href="https://www.meanwell.com/Upload/PDF/EMI_statement_en.pdf">https://www.meanwell.com/Upload/PDF/EMI_statement_en.pdf</a> ) 9. The ambient temperature derating of 3.5°C/1000m with fanless models and of 5°C/1000m with fan models for operating altitude higher than 2000m(6500ft). 10. The efficiency is measured at 75% load. ※ Product Liability Disclaimer : For detailed information, please refer to <a href="https://www.meanwell.com/serviceDisclaimer.aspx">https://www.meanwell.com/serviceDisclaimer.aspx</a>			

## ■ BLOCK DIAGRAM

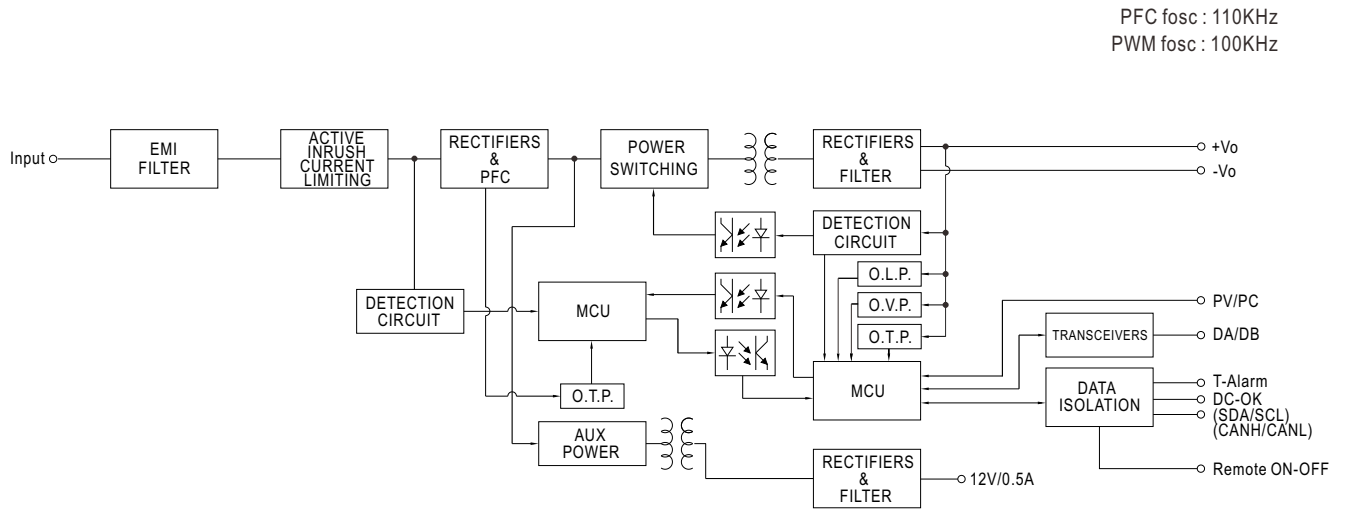

## ■ DERATING CURVE

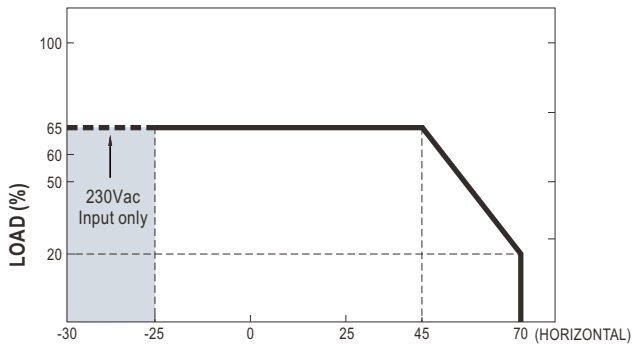

**AMBIENT TEMPERATURE WITH ADDITIONAL ALUMINUM PLATE(°C)**  
(450x450x3mm)

Note. Tcase max.  $\leq 70^{\circ}\text{C}$  and ambient temp must be within above de-rating curve.

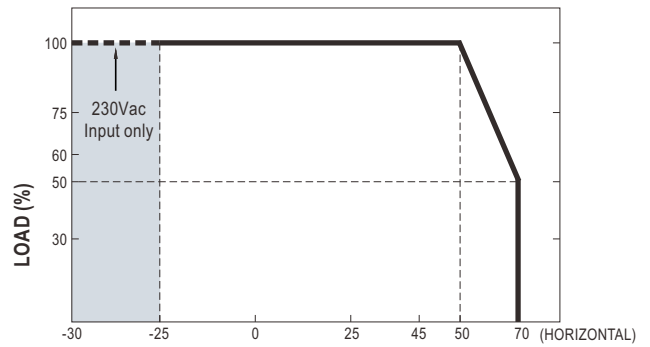

**AMBIENT TEMPERATURE WITH 128 CFM FAN\*2 OR WATER COOLING SYSTEM (°C)**

Note. Tcase max.  $\leq 45^{\circ}\text{C}$  and ambient temp must be within above de-rating curve.

## ■ STATIC CHARACTERISTICS

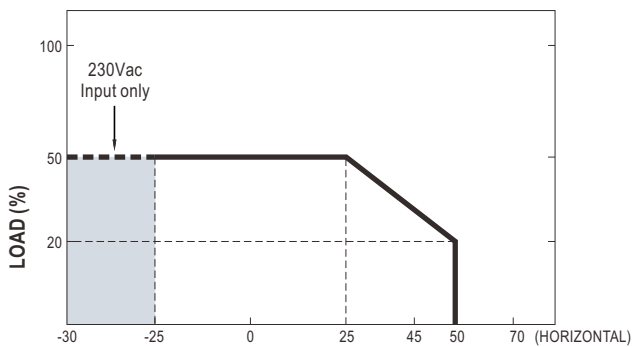

**AMBIENT TEMPERATURE WITHOUT ALUMINUM PLATE(°C)**

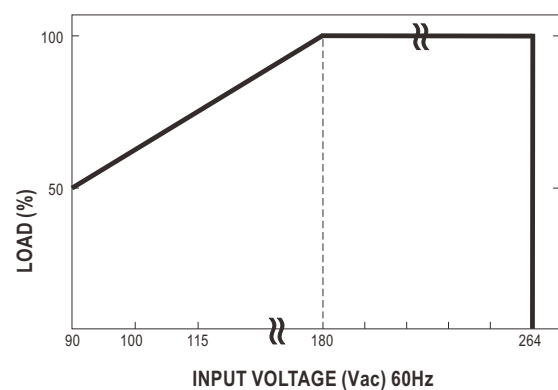

## FUNCTION MANUAL

### 1. Output Voltage Programming (or, PV / remote voltage programming / remote adjust / margin programming / dynamic voltage trim)

※ In addition to the adjustment via the built-in potentiometer, the output voltage can be trimmed by applying EXTERNAL VOLTAGE.

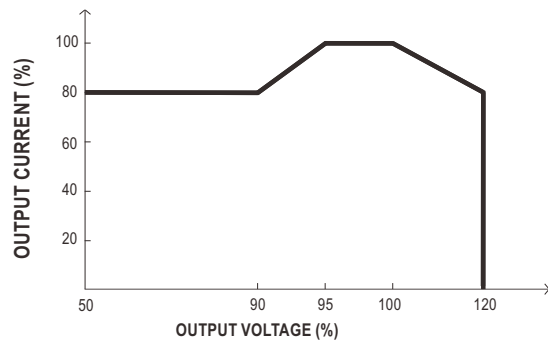
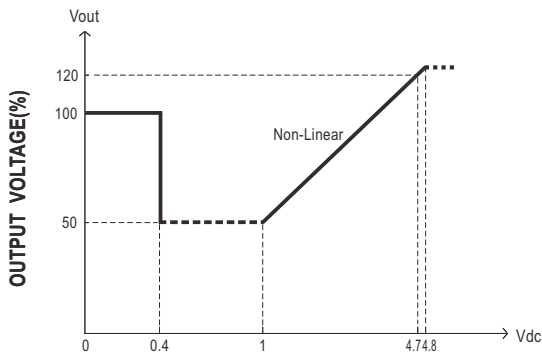
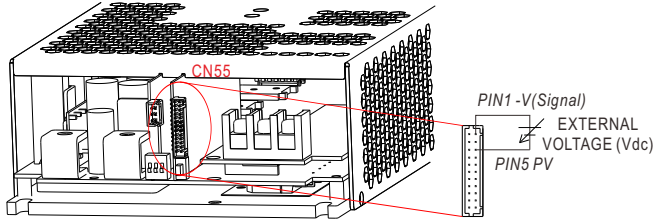

◎ The rated current should change with the Output Voltage Programming accordingly.

### 2. Output Current Programming (or, PC / remote current programming / dynamic current trim)

※ The output current can be trimmed to 20~100% of the rated current by applying EXTERNAL VOLTAGE.

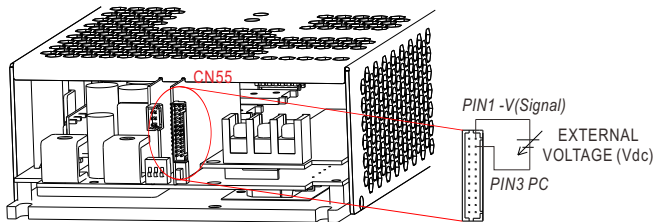

◎ Output will shut down after O/P voltage is below < 80% of Vset for 5 sec, re-power on to recover.

※ Covered by over temperature protection, auto de-rating function works under operation either in PC mode or under control by communication protocol.

T1(Typ.): Maximum ambient temperature of full load.

T2(Typ.): T1+5°C.

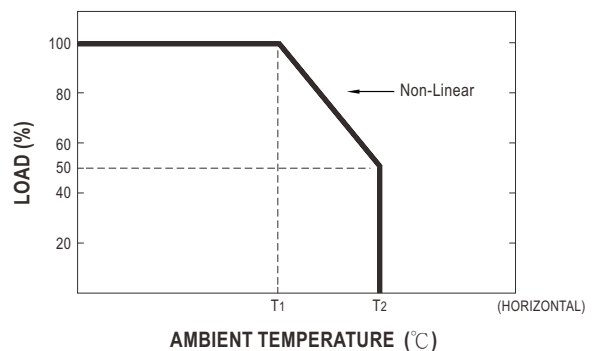
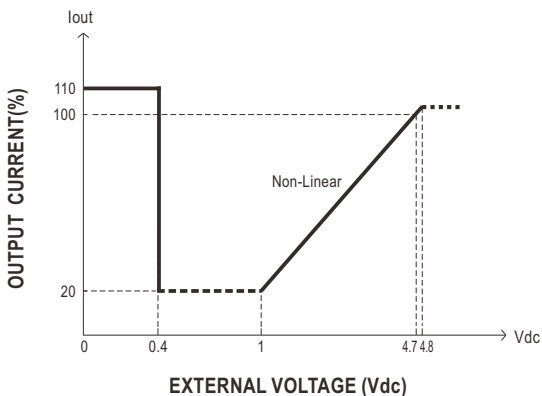

### 3.Remote ON-OFF Control

The power supply can be turned ON/OFF individually or along with other units in parallel by using the "Remote ON-OFF" function.

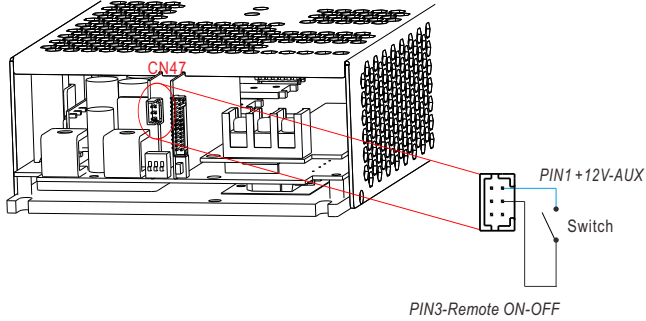

Remote ON-OFF	Power Supply Status
Short circuit	ON
Open circuit	OFF

### 4.DC-OK Signal

DC-OK signal is a TTL level signal. The maximum sourcing current is 10mA and the maximum external voltage is 5.6Vdc.

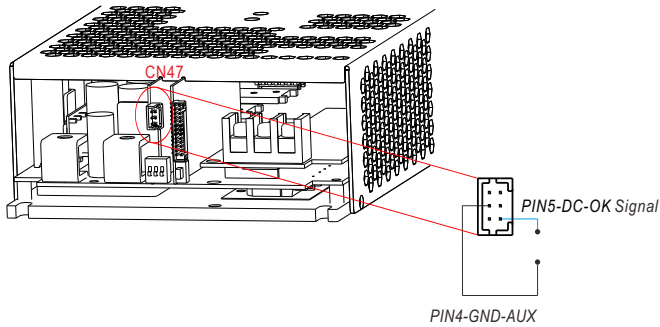

DC-OK signal	Power Supply Status
"High" >3.5~5.5Vdc	DC OK
"Low" <-0.5~0.5Vdc	Abnormal DC

### 5.Support CANBus or PMBus Communication

- ※ Communication provides function such as control, setting and monitorin , Parameters include output power, input voltage,ect.  
For more details, please refer to: <http://www.meanwell.com/manual.html>

### 6. Current Sharing

PHP-3500 has the built-in active current sharing function and can be connected in parallel, up to 4 units, to provide higher output power as exhibited below :

- ※ The power supplies should be paralleled using short and large diameter wiring and then connected to the load.
- ※ Difference of output voltages among parallel units should be less than 0.2V.
- ※ The total output current must not exceed the value determined by the following equation:  

$$\text{Maximum output current at parallel operation} = (\text{Rated current per unit}) \times (\text{Number of unit}) \times 0.9$$
- ※ When the total output current is less than 5% of the total rated current, or say  $(5\% \text{ of Rated current per unit}) \times (\text{Number of unit})$  the current shared among units may not be balanced.
- ※ Under parallel operation ripple of the output voltage may be higher than the SPEC at light load condition. It will go back to normal ripple level once the output load is more than 5%.
- ※ CN55/SW51 Function pin connection

Parallel	PSU1		PSU2		PSU3		PSU4	
	CN55	SW51	CN55	SW51	CN55	SW51	CN55	SW51
1 unit	X	ON	—	—	—	—	—	—
2 unit	V	ON	V	ON	—	—	—	—
3 unit	V	ON	V	OFF	V	ON	—	—
4 unit	V	ON	V	OFF	V	OFF	V	ON

(V : CN55 connected ; X : CN55 not connected.)

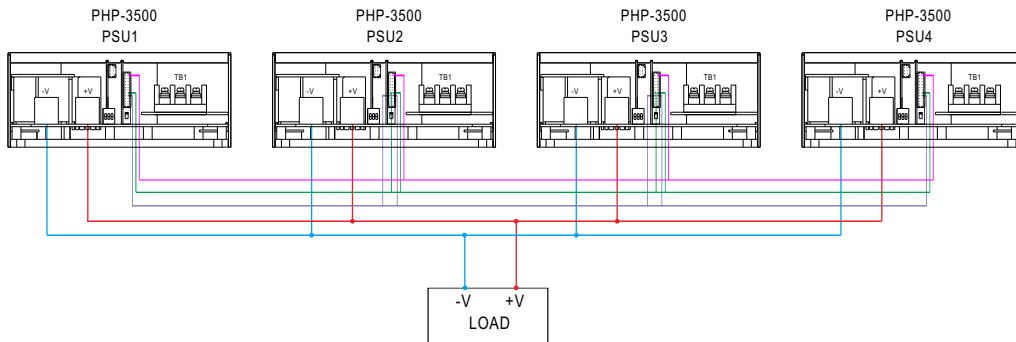
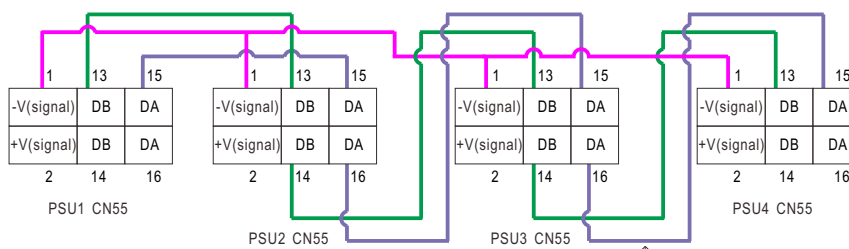

Fig 6.1



If the lines of CN55 are too long, they should be twisted in pairs to avoid the noise.

◎ DA, DB and -V(signal) are connected mutually in parallel.

## MECHANICAL SPECIFICATION

(Unit: mm, tolerance ±0.5mm)

Case No.278A

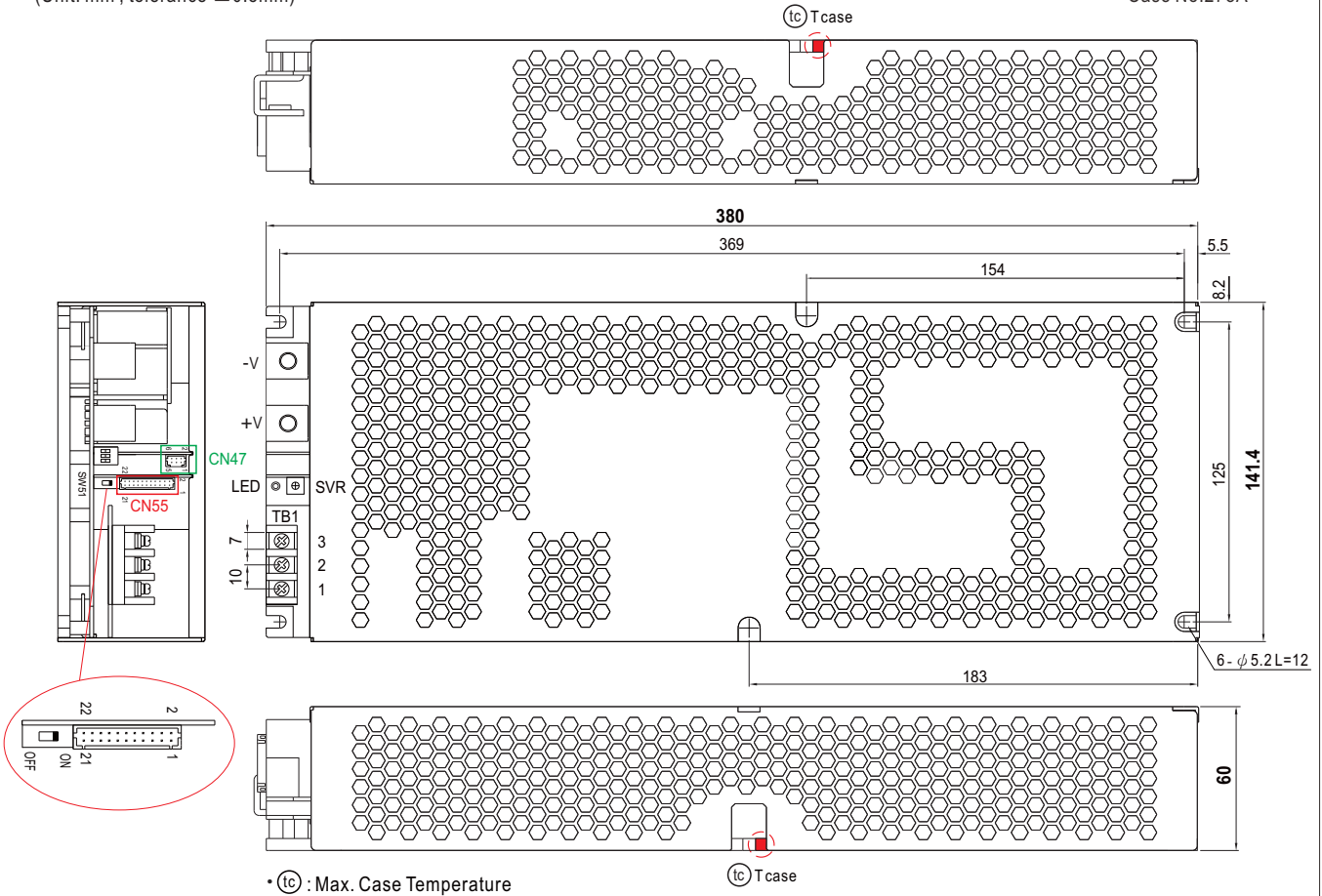

### AC Input Terminal(TB1) Pin NO. Assignment

Pin No.	Assignment	Terminal	Max mounting torque
1	AC/L	DECA T25-EM10-03	18Kgf-cm
2	AC/N		
3	⊥		

### ※DC Output Terminal Pin No. Assignment

Assignment	Diagram	Maximum mounting torque
+Vo, -Vo		10Kgf-cm

### ※ LED Status Indicators

LED	Description
Green	The power supply functions normally.
Red (Flashing)	The LED will flash with red light when internal temperature reaches 85°C; under this condition, the unit still operates normally without entering OTP. (In the meantime, an alarm signal will be sent out through the PMBus /CANBus interface.)
Red	Abnormal status (Over temperature protection, Overload protection)

### ※Control Pin No. Assignment(CN55) : HRS DF11-22DP-2DS or equivalent

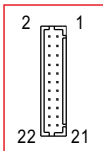

Mating Housing	HRS DF11-22DS or equivalent
Terminal	HRS DF11-22SC or equivalent

Pin No.	Function	Description
1	-V (Signal)	Negative output voltage signal.
2	+V (Signal)	Positive output voltage signal.
3,4	PC	Connection for constant current level programming. (Note.1)
5,6	PV	Connection for output voltage programming. (Note.1)
7,8,9,10,11,12	NC	----
13,14,15,16	DB,DA	Differential digital signal for parallel control. (Note.1)
17,18	GND-AUX(S)	The signal return is isolated from the output terminals (+Vo & -Vo).
19,20	SCL	For PMBus model: Serial Clock used in the PMBus interface. (Note.2)
	CANL	For CANBus model: Data line used in CANBus interface. (Note.2)
21,22	SDA	For PMBus model: Serial Data used in the PMBus interface. (Note.2)
	CANH	For CANBus model: Data line used in CANBus interface. (Note.2)

Note1: Non-isolated signal, referenced to [-V(signal)].

Note2: Isolated signal, referenced to GND-AUX(S).

※Control Pin No. Assignment(CN47) : HRS DF11-06DP-2DS or equivalent

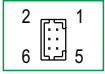

Mating Housing	HRS DF11-06DS or equivalent
Terminal	HRS DF11-**SC or equivalent

Pin No.	Function	Description
1	+12V-AUX	Auxiliary voltage output, 10.8~13.2Vdc, referenced to <i>GND-AUX</i> (pin 2). The maximum load current is 0.5A. This output has the built-in "Oring diodes" and is not controlled by the <i>Remote ON/OFF</i> control.
2	GND-AUX	Auxiliary voltage output GND. The signal return is isolated from the output terminals (+Vo & -Vo).
3	Remote ON-OFF	The unit can turn the output ON/OFF by electrical signal or dry contact between <i>Remote ON/OFF</i> and +12V-AUX. (Note.2) Short (10.8 ~ 13.2Vdc) : Power ON ; Open (-0.5 ~ 0.5Vdc) : Power OFF ; The maximum input voltage is 13.2Vdc.
4	GND-AUX(S)	The signal return is isolated from the output terminals (+Vo & -Vo).
5	DC-OK	High (3.5 ~ 5.5Vdc) : When the $V_{out} \leq 80\% \pm 5\%$ . Low (-0.5 ~ 0.5Vdc) : When $V_{out} \geq 80\% \pm 5\%$ . The maximum sourcing current is 10mA and only for output. (Note.2)
6	T-ALARM	High (3.5 ~ 5.5Vdc) : When the internal temperature exceeds the limit of temperature alarm. Low (-0.5 ~ 0.5Vdc) : When the internal temperature is normal, and when fan works normally. The maximum sourcing current is 10mA and only for output(Note.2)

### 1. Operate with additional aluminum plate

In order to meet the "Derating Curve" and the "Static Characteristics", PHP-3500 series must be installed onto an aluminum plate (or the cabinet of the same size) on the bottom. The size of the suggested aluminum plate is shown as below. And for optimizing thermal performance, the aluminum plate must have an even and smooth surface (or coated with thermal grease), and PHP-3500 series must be firmly mounted at the center of the aluminum plate.

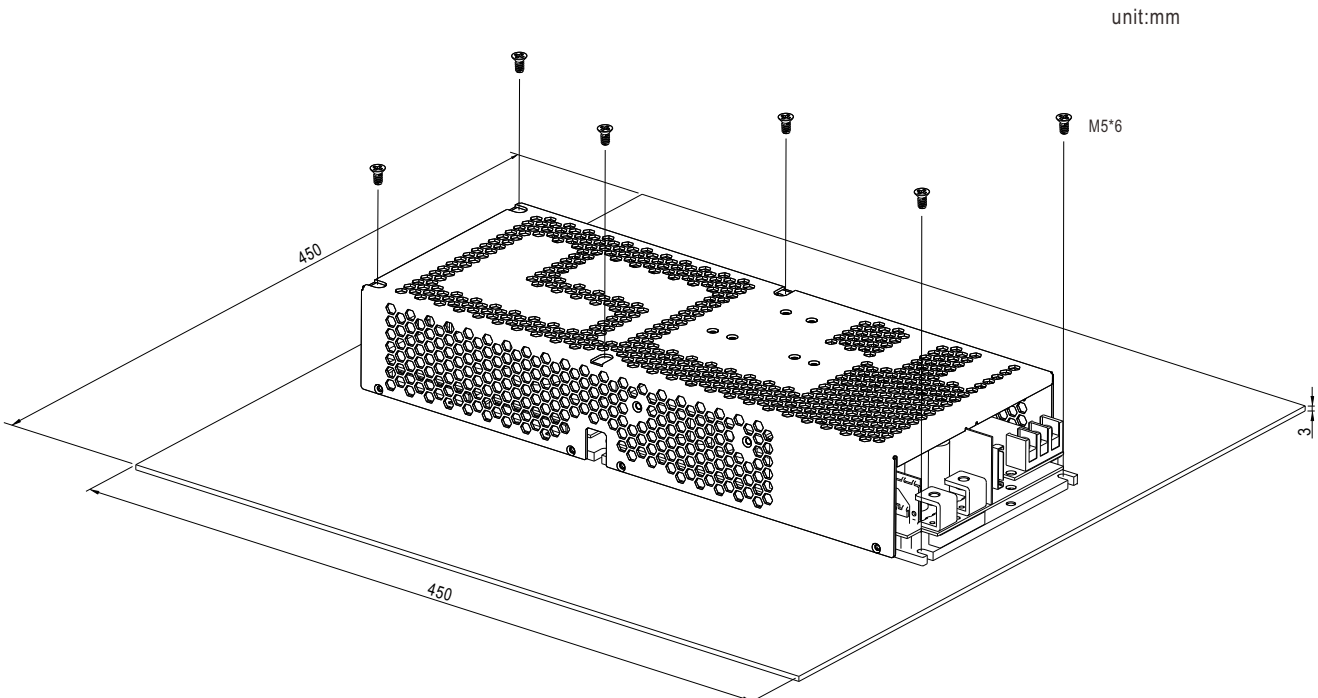

**2. Suitable for conduction cooling**

Inlet temperature: 25°C

Flow rate (minimum): 1 LPM

If optional cold plate is in need, please contact MEAN WELL for details.

Ordering No.: PGG1WHS-656

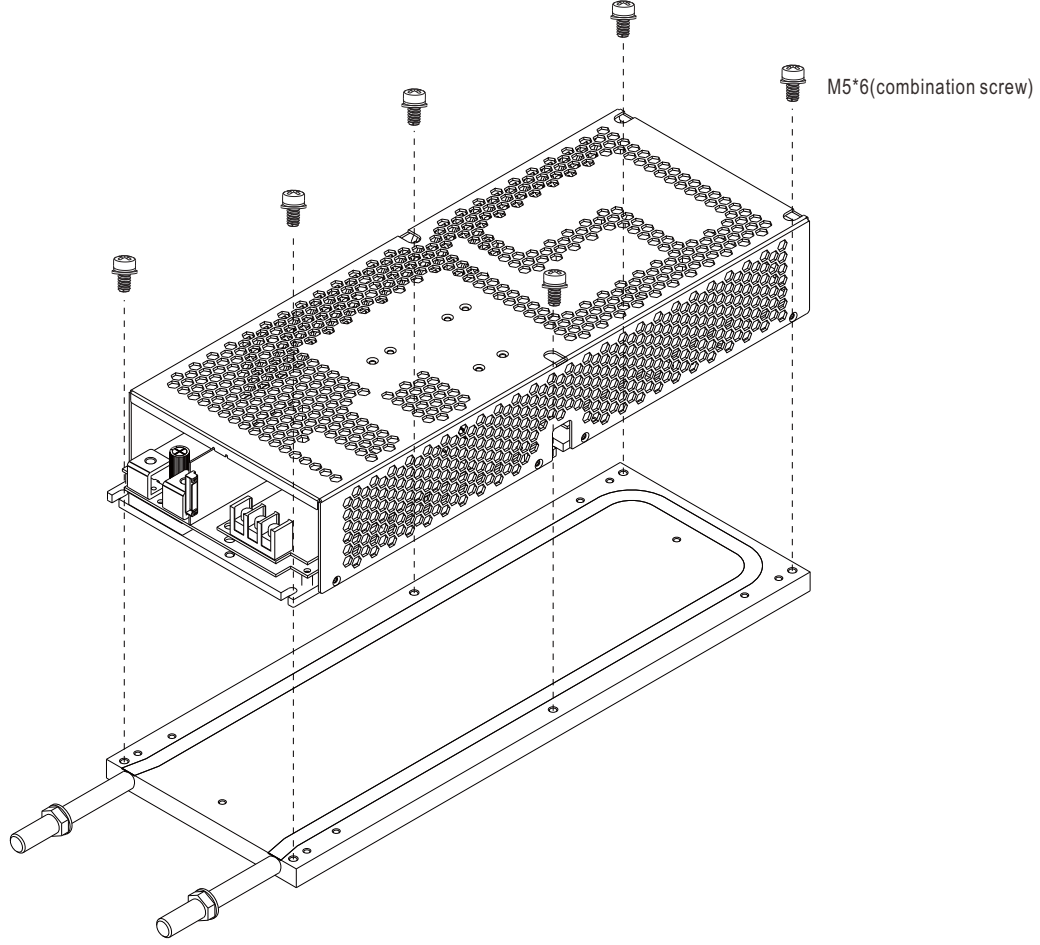
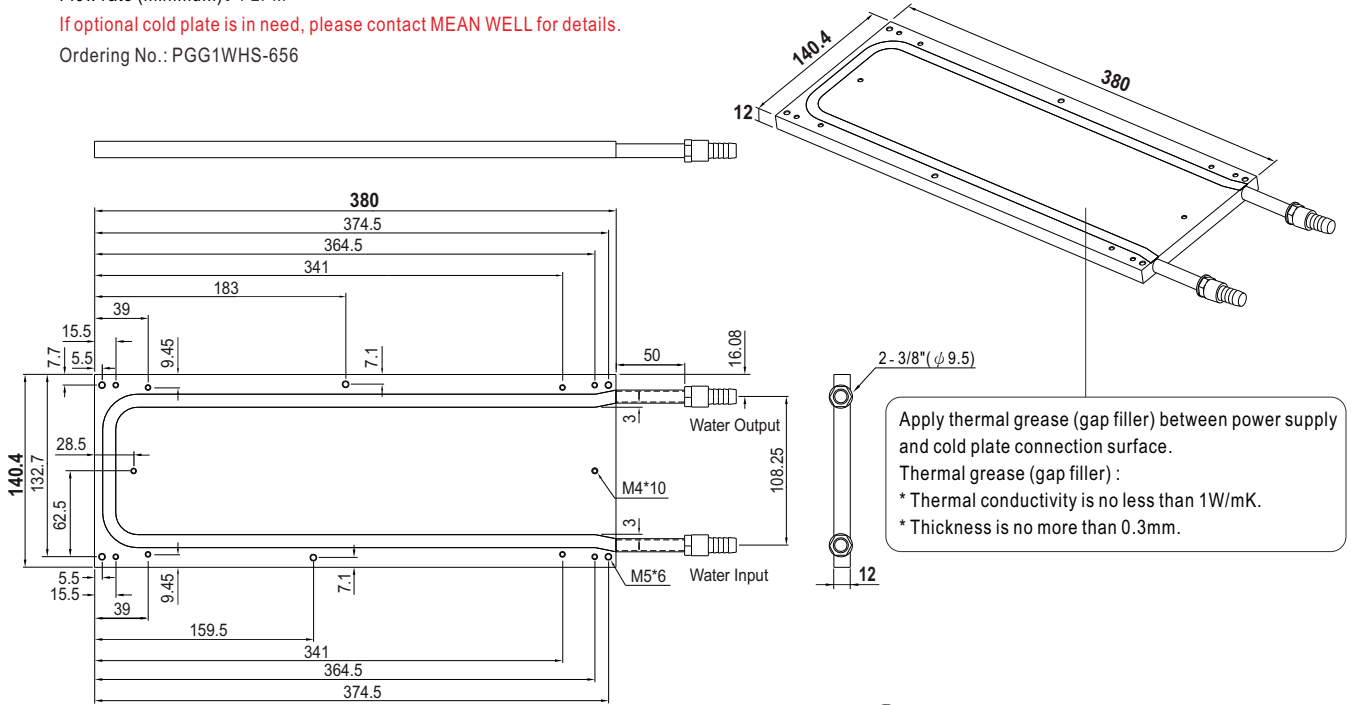

3. With 128CFM FAN x 2

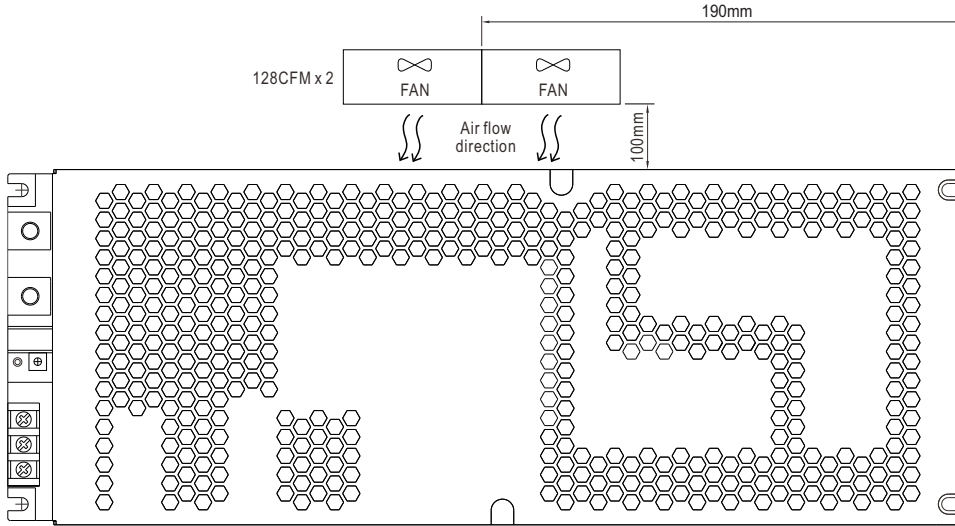

4. Condensation - Safe operating area.

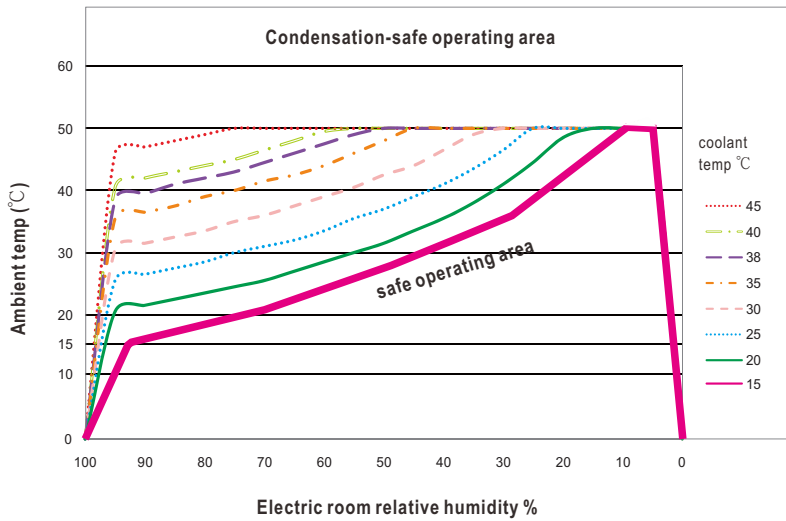

 [www.simpex.ch](http://www.simpex.ch)

Besuchen Sie unseren Simpex E-Shop mit über 12'000 Produkten.

Er bietet Ihnen eine breite Funktionsvielfalt, sowie intelligente Suchfunktionen. Ob Sie den Shop als Einkaufsplattform oder als Produktfinder nutzen – im Simpex E-Shop haben Sie alle Informationen schnell und tagesaktuell zur Hand.

24h und das 365 Tage im Jahr.



## Hauptsitz

### **Simpex Electronic AG**

Binzackerstrasse 33

CH-8620 Wetzikon

Telefon +41 44 931 10 10

E-Mail [contact@simpex.ch](mailto:contact@simpex.ch)

Internet [www.simpex.ch](http://www.simpex.ch)