



Test Report: XLG-20- M

21W Constant Current Mode LED Driver

■ DESIGN VERIFY TEST

- Output Function Test
- Input Function Test
- Protection Function Test
- Control Function Test
- Component Stress Test

■ SAFETY & E.M.C. TEST

- Safety Test
- E.M.C. Test

■ RELIABILITY TEST

- ENVIRONMENT TEST

DESIGN VERIFY TEST

OUTPUT FUNCTION TEST

N O	TEST ITEM	SPECIFICATION	TEST CONDITION	RESULT
1	CURRENT ACCURACY	±8%	I/P: 230 VAC I/P:115VAC O/P:FULL LOAD Ta:25°C LEDH MODE TEST	-4%~1.66%
2	LINE REGULATION	< 3%	I/P: 230 VAC I/P:115VAC O/P:FULL LOAD Ta:25°C LEDH MODE TEST	2.4%
3	OPEN CIRCUIT VOLTAGE (max)	50V	I/P: 230VAC O/P:NO LOAD CP: OPEN Ta:25°C	45.27V
4	CONSTANT CURRENT OPERATION VOLTAGE	CH1: 25.2 V~ 42V	I/P: 230 VAC O/P:FULL LOAD Ta:25°C LEDH MODE TEST	20.8V~ 42.8V /230VAC
5	CURRENT RIPPLE	< 20%	I/P: 230 VAC I/P:115VAC O/P:FULL LOAD Ta:25°C LEDH MODE TEST	< 20%
6	SET UP TIME (Max)	230VAC/500ms 115VAC/500ms	I/P: 230 VAC I/P: 115 VAC O/P:FULL LOAD Ta:25°C LEDH MODE TEST	230VAC/ 266 ms 115 VAC/ 272ms

INPUT=230VAC/50HZ @ FULL LOAD

CH1 : Output Voltage CH2 : AC Input Voltage

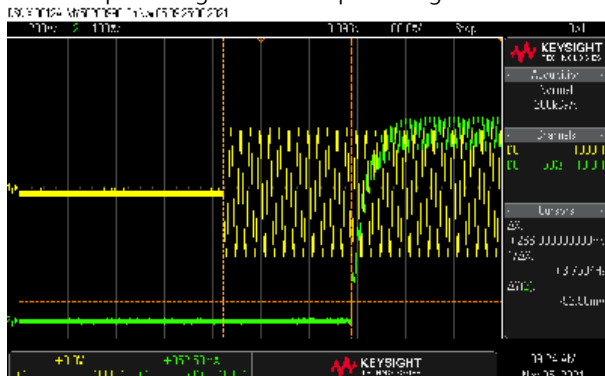

INPUT=115VAC/60HZ @ FULL LOAD

CH1 : Output Voltage CH2 : AC Input Voltage

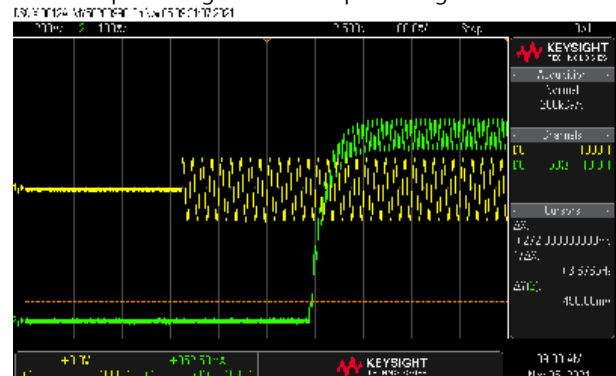

7	RISE TIME (Max)	230VAC/150ms 115VAC/150ms	I/P: 230 VAC I/P: 115 VAC O/P: FULL LOAD Ta:25°C LEDH MODE TEST	230VAC/74 ms 115 VAC/ 74 ms
---	-----------------	------------------------------	--	--------------------------------

INPUT=230VAC/50HZ @ FULL LOAD
CH1 : Output Voltage

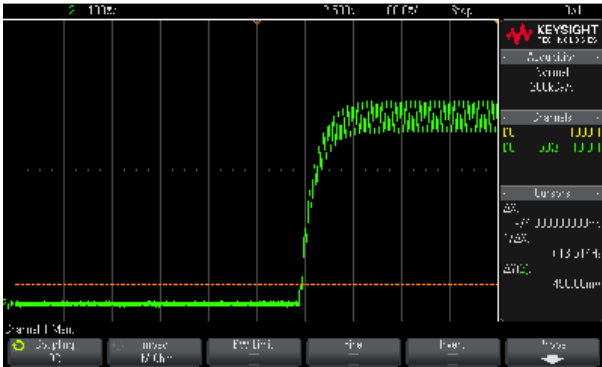

INPUT=115VAC/60HZ @ FULL LOAD
CH1 : Output Voltage

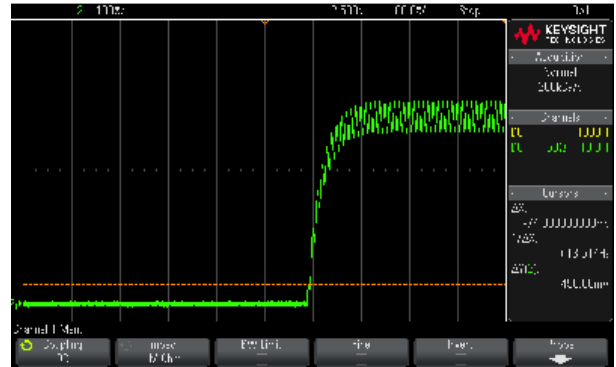

8 DIMMING OPERATION (for B-Type)

※ 3 in 1 dimming function (for B-Type)

- Output constant current level can be adjusted by applying one of the three methodologies between DIM+ and DIM-: 1 ~ 10VDC, or 10V PWM signal or resistance.
- Direct connecting to LEDs is suggested. It is not suitable to be used with additional drivers.
- Dimming source current from power supply: 103µA (typ.)

◎ Applying additive 1 ~ 10VDC

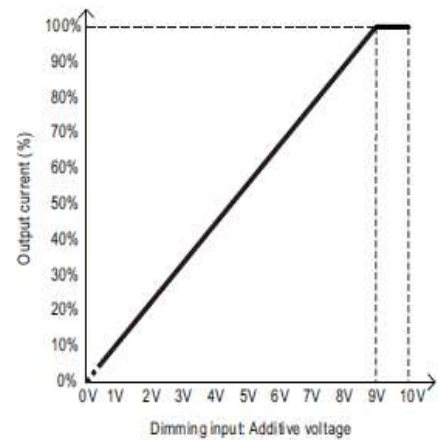
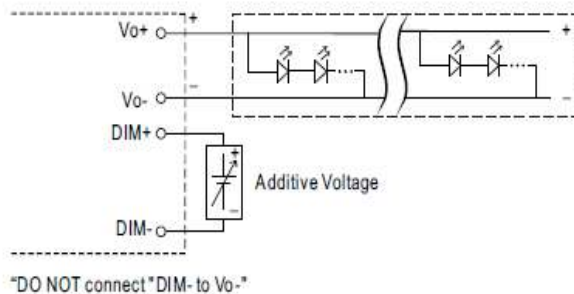

◎ Applying additive 10V PWM signal (frequency range 100Hz ~ 3KHz):

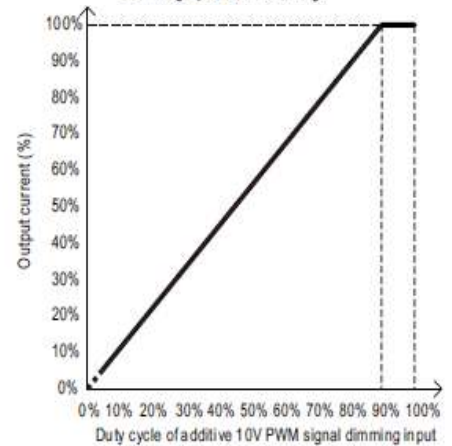
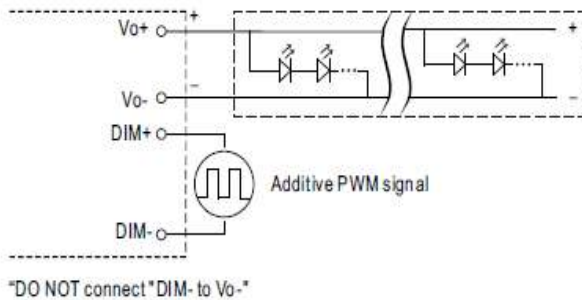

⊙ Applying additive resistance:

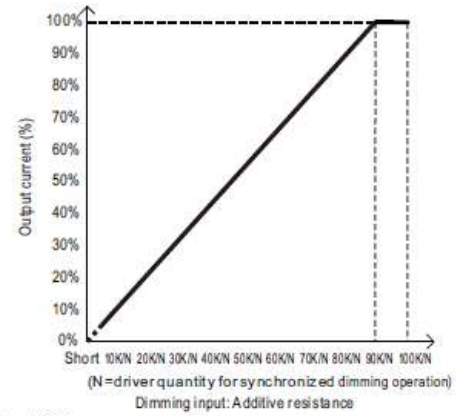
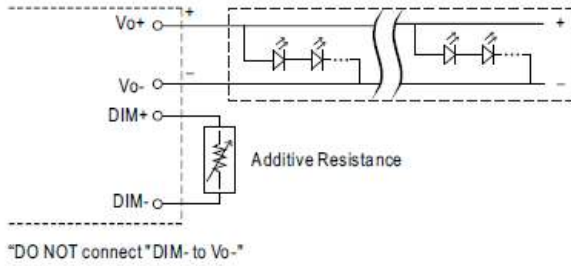

Note: 1. Min. dimming level is about 3% and the output current is not defined when $0\% < I_{out} < 3\%$.

I/P : 230 VAC O/P : DIMMING TEST

	V	1V	2V	3V	4V	5V	6V	7V	8V	9V	10V	OPEN
1	Output Current	0.060 A	0.11 2A	0.166A	0.221A	0.270A	0.325A	0.377A	0.436A	0.487A	0.496A	0.496A
	%	10.91 %	20.4 4%	30.18 %	40.15 %	49.09 %	59.05 %	68.51 %	79.20 %	88.58 %	99.16%	99.12%
2	PWM	10%	20%	30%	40%	50%	60%	70%	80%	90%	100%	OPEN
	Output Current (100Hz)	0.062 A	0.11 5A	0.168A	0.220A	0.275A	0.329A	0.381A	0.434A	0.485A	0.495A	0.493A
	%	11.20 %	20.9 5%	30.47 %	40.00 %	49.96 %	59.78 %	69.31 %	78.98 %	88.22 %	99.04%	98.64%
3	R	10K	20K	30K	40K	50K	60K	70K	80K	90K	100K	OPEN
	Output Current	0.061 A	0.11 8A	0.163A	0.217A	0.273A	0.326A	0.387A	0.435A	0.485A	0.496A	0.495A
	%	11.02 %	21.4 2%	29.67 %	39.45 %	49.67 %	59.29 %	70.42 %	79.13 %	88.13 %	99.14%	98.96%

TEST RESULT : OK

INPUT FUNCTION TEST

N	TEST ITEM	SPECIFICATION	TEST CONDITION	RESULT
1	INPUT VOLTAGE RANGE	90VAC~305 VAC	(1) I/P:TESTING O/P:FULL LOAD Ta:25°C	(1) 85VAC ~308VAC
			I/P: LOW-LINE-3V=87 VAC HIGH-LINE+10V=315 VAC O/P:FULL/MIN LOAD (PLEASE CHECK DERATING CURVE) ON: 30 Sec OFF: 30 Sec 10MIN (POWER ON/OFF NO DAMAGE)	TEST:OK

2	INPUT FREQUENCY RANGE	47HZ ~63 HZ NO DAMAGE	I/P: 90 VAC ~305VAC O/P:FULL~MIN LOAD Ta:25°C	OK
3	INPUT CURRENT (TYP)	277VAC/0.2A 230 VAC/0.2A 115 VAC/0.3A	I/P: 277VAC/230 VAC/115 VAC O/P:FULL LOAD Ta:25°C LEDH MODE TEST	I= 0.093A/277VAC I =0.105A/ 230VAC I =0.206A/ 115VAC
4	NO LOAD POWER CONSUMPTION	<0.5W	I/P: 230 VAC O/P:NO LOAD Ta:25°C	0.421W
5	LEAKAGE CURRENT	< 0.75mA / 277VAC	I/P: 277 VAC O/P:Min LOAD Ta:25°C	L-FG: 0.427 mA N-FG: 0.426mA
6	POWER FACTOR(TYP)	0.95/230 VAC FULL LOAD 0.97/115 VAC FULL LOAD 0.91/277 VAC FULL LOAD	I/P: 230 VAC/115VAC/277VAC O/P:FULL LOAD Ta:25°C LEDH MODE TEST	PF= 0.976/230V/100%LOAD PF=0.997/115V/100%LOAD PF=0.919/277V/100%LOAD

P.F vs LOAD

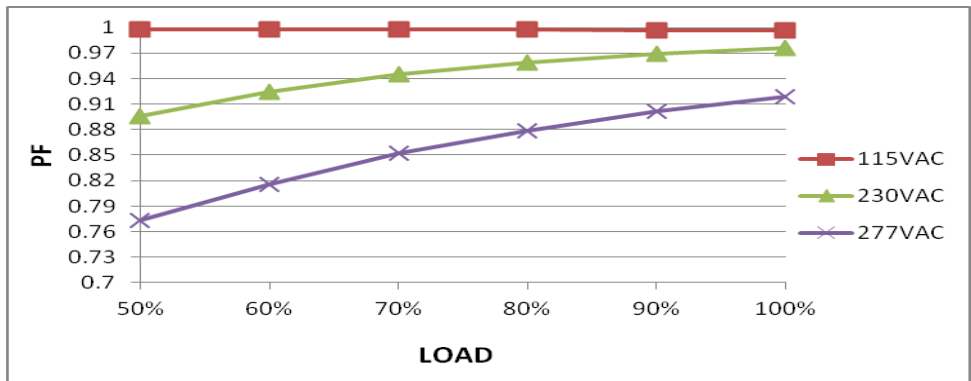

7	EFFICIENCY (TYP)	88.5 %	I/P: 230 VAC O/P:FULL LOAD Ta:25°C LEDH MODE TEST	90.46%
---	------------------	--------	---	--------

EFFICIENCY vs LOAD

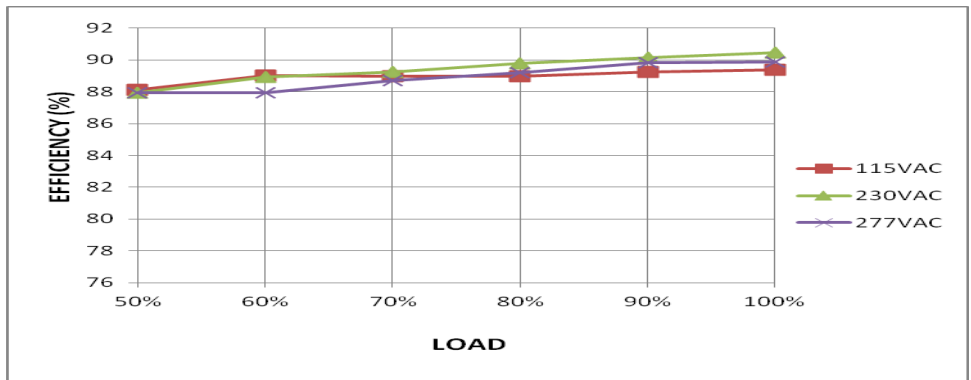

8	INRUSH CURRENT (TYP)	230 V/ 50A COLD START (twidth=350us measured at 50% Ipeak) COLD START	I/P: 230 VAC O/P:FULL LOAD Ta:25°C LEDH MODE TEST	I = 3.74A/ 230VAC T50= 36 us
---	----------------------	---	---	-------------------------------------

INPUT=230VAC/50HZ @ FULL LOAD
CH2 : AC Input Voltage CH4 : Input current (1V=1A)

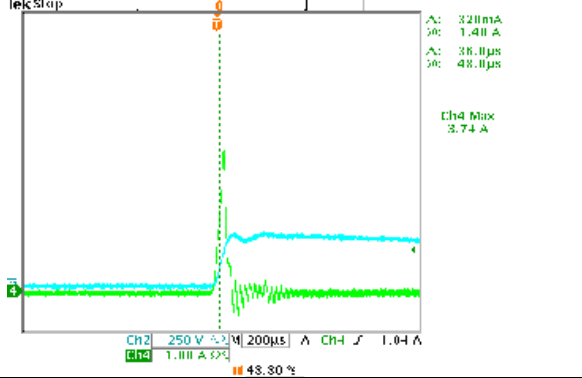

9	TOTAL HARMONIC DISTORTION	THD<20%@load, ≥ 50% at 230VAC/115VAC, load, ≥ 75% at 277VAC	I/P : 277VAC /230VAC/115VAC O/P : 75%LOAD 50% LOAD Ta : 25°C	THD : 5.31% 115VAC 50% THD : 12.55% 230VAC 50% THD : 15.38% 277VAC 75%
---	---------------------------	---	---	--

THD vs LOAD

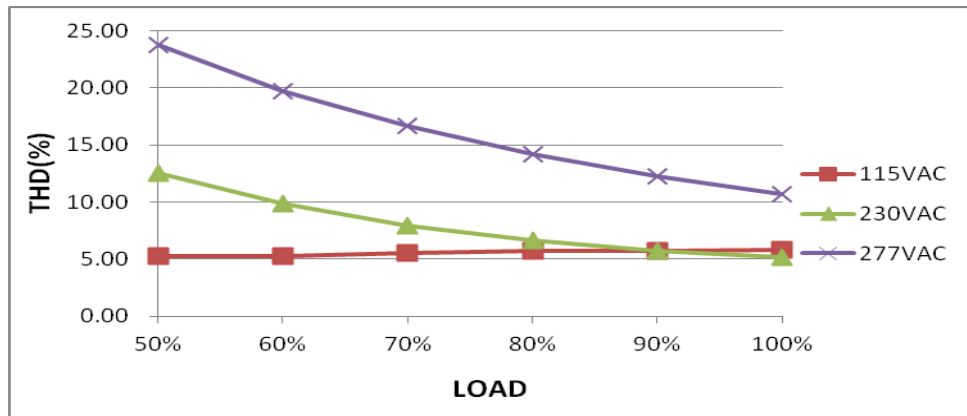

ROTECTION FUNCTION TEST

NO	TEST ITEM	SPECIFICATION	TEST CONDITION	RESULT
1	SHORT PROTECTION	SHORT EVERY OUTPUT 1 HOUR NO DAMAGE	I/P: 305VAC I/P: 90 VAC O/P: FULL LOAD Ta:25°C	NO DAMAGE PROTECTION TYPE : Hiccup mode, recovers automatically after fault condition is removed.

COMPONENT STRESS TEST

NO	TEST ITEM	SPECIFICATION	TEST CONDITION	RESULT
1	PWM Transistor (D to S) or (C to E) Peak Voltage	Q1 Rated 6 A/ 800V	AC ON/OFF I/P:High-Line +3V =308v VDS: O/P: (1)LEDmax (2) LEDmax continue (3) LEDmin (4) LEDmin continue (5) Output Short I/P:Low-Line -3V = 87V VDS: O/P: (1)LEDmax (2) LEDmax continue (3) LEDmin (4) LEDmin continue (5) Output Short Ta:25°C	308V VDS: (1) 592V (2) 584V (3) 540V (4) 535V (5) 616V 87V VDS: (1) 274V (2) 270V (3) 220V (4) 215V (5) 134V
2	Diode Peak Voltage	D100 Rated 3 A/ 600 V	AC ON/OFF I/P:High-Line +3V =308 V Q101 : VDS: O/P: (1)LEDmax (2) LEDmax continue (3) Output Short Ta:25°C	(1) 193V (2) 189V (3) 199V
3	Control IC Voltage Test	PWM IC U1 Rated -0.3V~30V	AC ON/OFF I/P:High-Line +3V =308 V O/P: (1)LEDmax (2) LEDmax continue (3) LEDmin (4) LEDmin continue (5) NO LOAD Ta:25°C	U1 (1) 17.9V (2) 13.9V (3) 17.8V (4) 13.7V (5) 13.7V
4	Clamp Diode Peak Voltage	D11 Rated : 400V 2A	AC ON/OFF I/P : High-Line +3V = 308 V O/P: (1)LEDmax (2) LEDmax continue (3) LEDmin (4) LEDmin continue (5) NO LOAD Ta : 25°C	D11 (1)173V (2)167V (3)157V (4)157V (5)169V

SAFETY & EMC TEST

SAFETY TEST

NO	TEST ITEM	SPECIFICATION	TEST CONDITION	RESULT
1	WITHSTAND VOLTAGE	I/P-O/P: 3.75KVAC/min I/P-FG: 2 KVAC/min O/P-FG:1.5KVAC/min	I/P-O/P: 4.125 KVAC/min I/P-FG: 2.4KVAC/min O/P-FG: 1.8 KVAC/min Ta:25°C	I/P-O/P: 3.429mA I/P-FG:3.614mA O/P-FG:2.108mA NO DAMAGE
2	ISOLATION RESISTANCE	I/P-O/P:500VDC>100MΩ I/P-FG: 500VDC>100MΩ O/P-FG:500VDC>100MΩ	I/P-O/P: 500 VDC I/P-FG: 500 VDC O/P-FG: 500 VDC Ta:25°C	I/P-O/P: 9999GΩ I/P-FG: 9999G Ω O/P-FG: 9999G Ω NO DAMAGE
3	GROUNDING CONTINUITY	FG(PE) TO CHASSIS OR TRACE < 100 mΩ	40A / 2min Ta:25°C	12 mΩ

E.M.C TEST

NO	TEST ITEM	SPECIFICATION	TEST CONDITION	RESULT
1	HARMONIC	EN61000-3-2 CLASS C	I/P: 230VAC/50Hz O/P:50%/FULL LOAD Ta:25°C	PASS
2	CONDUCTION	EN55015	I/P: 230 VAC (50HZ) O/P:FULL/50% LOAD Ta:25°C	PASS Test by certified Lab
3	RADIATION	EN55015	I/P: 230 VAC (50HZ) O/P:FULL LOAD Ta:25°C	PASS Test by certified Lab
4	E.S.D	EN61000-4-2 INDUSTRY AIR : 8KV / Contact : 4KV	I/P: 230 VAC/50HZ O/P:FULL LOAD Ta:25°C	CRITERIA A
5	E.F.T	EN61000-4-4 INDUSTRY INPUT: 2KV	I/P: 230 VAC/50HZ O/P:FULL LOAD Ta:25°C	CRITERIA A
6	SURGE	IEC61000-4-5 INDUSTRY L-N :2KV L,N-PE:4KV	I/P: 230 VAC/50HZ O/P:FULL LOAD Ta:25°C	CRITERIA B
7	Test by certified Lab & Test Report Prepare Any contradictions of the test results, please refer to the latest EMC test report			

RELIABILITY TEST

ENVIRONMENT TEST

NO	TEST ITEM	SPECIFICATION	TEST CONDITION	RESULT																																																												
1	TEMPERATURE RISE TEST	MODEL : XLG-20-M-B 1. ROOM AMBIENT BURN-IN : 2 HRS I/P : 230VAC O/P : FULL LOAD Ta=32.3 °C 2. HIGH AMBIENT BURN-IN : 2 HRS I/P : 230VAC O/P : FULL LOAD Ta=61.1 °C																																																														
				<table border="1"> <thead> <tr> <th>NO</th> <th>Position</th> <th>ROOM AMBIENT Ta=32.3 °C</th> <th>HIGH AMBIENT Ta=61.1°C</th> </tr> </thead> <tbody> <tr><td>1</td><td>D5</td><td>45.9°C</td><td>74.9°C</td></tr> <tr><td>2</td><td>BD1</td><td>47.1°C</td><td>75.7°C</td></tr> <tr><td>3</td><td>C13</td><td>49.3°C</td><td>78.1°C</td></tr> <tr><td>4</td><td>U1</td><td>47.8°C</td><td>76.8°C</td></tr> <tr><td>5</td><td>Q1</td><td>50.5°C</td><td>80.1°C</td></tr> <tr><td>6</td><td>D10</td><td>34.8°C</td><td>79.4°C</td></tr> <tr><td>7</td><td>Q10</td><td>60.0°C</td><td>88.8°C</td></tr> <tr><td>8</td><td>T1</td><td>50.9°C</td><td>79.6°C</td></tr> <tr><td>9</td><td>C101</td><td>46.1°C</td><td>74.9°C</td></tr> <tr><td>10</td><td>C102</td><td>47.4°C</td><td>76.2°C</td></tr> <tr><td>11</td><td>D100</td><td>55.7°C</td><td>84.8°C</td></tr> <tr><td>12</td><td>D600</td><td>53.6°C</td><td>81.9°C</td></tr> <tr><td>13</td><td>U600</td><td>48.2°C</td><td>77.2°C</td></tr> <tr><td>14</td><td>TC</td><td>43.5°C</td><td>72.2°C</td></tr> </tbody> </table>	NO	Position	ROOM AMBIENT Ta=32.3 °C	HIGH AMBIENT Ta=61.1°C	1	D5	45.9°C	74.9°C	2	BD1	47.1°C	75.7°C	3	C13	49.3°C	78.1°C	4	U1	47.8°C	76.8°C	5	Q1	50.5°C	80.1°C	6	D10	34.8°C	79.4°C	7	Q10	60.0°C	88.8°C	8	T1	50.9°C	79.6°C	9	C101	46.1°C	74.9°C	10	C102	47.4°C	76.2°C	11	D100	55.7°C	84.8°C	12	D600	53.6°C	81.9°C	13	U600	48.2°C	77.2°C	14	TC	43.5°C	72.2°C
NO	Position	ROOM AMBIENT Ta=32.3 °C	HIGH AMBIENT Ta=61.1°C																																																													
1	D5	45.9°C	74.9°C																																																													
2	BD1	47.1°C	75.7°C																																																													
3	C13	49.3°C	78.1°C																																																													
4	U1	47.8°C	76.8°C																																																													
5	Q1	50.5°C	80.1°C																																																													
6	D10	34.8°C	79.4°C																																																													
7	Q10	60.0°C	88.8°C																																																													
8	T1	50.9°C	79.6°C																																																													
9	C101	46.1°C	74.9°C																																																													
10	C102	47.4°C	76.2°C																																																													
11	D100	55.7°C	84.8°C																																																													
12	D600	53.6°C	81.9°C																																																													
13	U600	48.2°C	77.2°C																																																													
14	TC	43.5°C	72.2°C																																																													
2	LOW TEMPERATURE TURN ON TEST	TURN ON AFTER 2 HOUR	I/P : 230VAC/100VAC O/P : 100%LOAD Ta= -45/-30 °C	TEST : OK																																																												
3	HIGH HUMIDITY HIGH TEMPERATURE HIGH VOLTAGE TURN ON TEST	AFTER 12 HOURS IN CHAMBER ON CONTROL 60 °C NO DAMAGE	I/P : 315 VAC O/P : FULL LOAD Ta=60 °C HUMIDITY= 95 %R.H	TEST : OK																																																												
4	TEMPERATURE COEFFICIENT	± 0.03 %/(0°C~50°C)	I/P : 230 VAC O/P : FULL LOAD	± 0.001 %/°C(0~50°C)																																																												
5	STORAGE TEMPERATURE TEST	-40~80°C	1. Thermal shock Temperature : -45°C~ +90°C 2. Temperature change rate : 25°C / MIN 3. Dwell time low and high temperature : 30 MIN/EACH 4. Total test cycle : 10CYCLE 5. Input/Output condition : STATIC TEST : OK																																																													

6	THERMAL SHOCK TEST	-40~60°C	1. Thermal shock Temperature : -45°C~ +65°C 2. Temperature change rate : 25°C / MIN 3. Dwell time low and high temperature : 30 MIN/EACH 4. Total test cycle : 16 CYCLE 5. Input/Output condition : 15cycle:230V/ FULL LOAD AC ON 3sec/AC OFF 1sec TEST 1cycle:230V/ FULL LOAD Burn In Test TEST : OK
7	VIBRATION TEST	10 ~ 500Hz, 5G 10min./1cycle, 60min. each along X, Y, Z axes	1 Carton & 1 Set (1) Waveform : Sine Wave (2) Frequency : 10~500Hz (3) Sweep Time : 12min/sweep cycle (4) Acceleration : 6G (5) Test Time : 180min in each axis (X.Y.Z) (6) Ta : 25°C
8	CAPACITOR LIFE CYCLE	SUPPOSE C102 IS THE MOST CRITICAL COMPONENT (1) I/P : 230VAC O/P : FULL LOAD Tc=80 °C LIFE TIME (2) I/P : 230VAC O/P : 75% LOAD Tc=80 °C LIFE TIME (3) I/P : 230VAC O/P : 50% LOAD Tc= 80 °C LIFE TIME	(1) 63550HRS (2) 65853HRS (3) 67750HRS
9	MTBF	Conducted by Parts Stress Analysis Prediction 5721.2K hrs min. Telcordia SR-332 (Bellcore); 747.1K hrs min. MIL-HDBK-217F (25°C)	
10	Ongoing Reliability Test	I/P : 230VAC O/P : FULL LOAD Ta=50°C Demonstration Mean Time Between Failure : 50,000 hours	

TEST RESULT	TESTER	REVIEW	APPROVAL
PASS	WUWQ/ZHOUB	WENF	LINKX