



ProLight PDSQ-17FVL-D2030
17W Dual Color COB
Light-Engine LEDs
Technical Datasheet
Version: 1.1

ProLight Opto ® ProEngine Series

Features

- High flux density of lighting source
- Good color uniformity
- RoHS compliant
- More energy efficient than incandescent and most halogen lamps
- No UV
- Long lifetime

Main Applications

- Par lighting
- LED Bulb
- Ceiling lighting
- Spot lighting
- Down lighting

Introduction

·The input power is 17 Watt, the multi-chip ultra high power ProEngine Series delivers never before seen luminous flux output from a single emitter. The superficial illuminating nature of ProEngine makes them the preference in Par lighting, typical applications include commercial down lighting, LED bulb, accent lighting, ceiling lighting and spot lighting.

Emitter Mechanical Dimensions

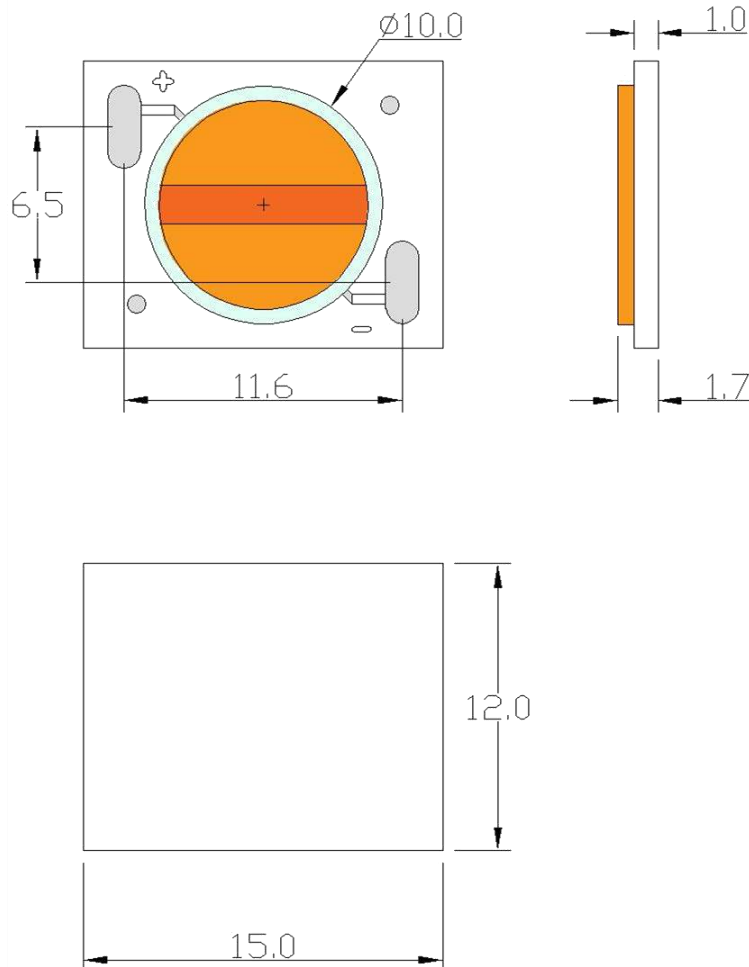

Notes:

1. Solder pads are labeled "+" and "-" to denote positive and negative, respectively.
2. Drawing not to scale.
3. All dimensions are in millimeters.
4. Unless otherwise indicated, tolerances are $\pm 0.30\text{mm}$.
5. **Please do not use a force of over 0.3kgf impact or pressure on the lens of the LED, otherwise it will cause a catastrophic failure.**

*The appearance and specifications of the product may be modified for improvement without notice.

Flux Characteristics, $T_c = 25^\circ\text{C}$

Radiation Pattern	Color	Part Number COB	DC Forward Current (mA)		Luminous Flux Φ_v (lm)		CRI Typ.
			50	350	Minimum	Typical	
Lambertian	Warm White	PDSQ-17FVL-D2030	50		110	120	95
			350		1000	1100	

- ProLight maintains a tolerance of $\pm 7\%$ on flux and power measurements.
- Please do not drive at rated current more than 1 second without proper heat sink.

Electrical Characteristics, $T_c = 25^\circ\text{C}$

Color	DC Forward Current (mA)	Forward Voltage V_F (V)			Thermal Resistance Junction to Board ($^\circ\text{C}/\text{W}$)
		Min.	Typ.	Max.	
Warm White	50	26	31	34	3.9
	350	34	37	40	

- ProLight maintains a tolerance of $\pm 1\text{V}$ for Voltage measurements.

Optical Characteristics, $T_c = 25^\circ\text{C}$

Color	DC Forward Current (mA)	Color Temperature CCT			Total included Angle (degrees) $\theta_{0.90V}$	Viewing Angle (degrees) $2\theta_{1/2}$
		Min.	Typ.	Max.		
Warm White	50	1920 K	2000 K	2090 K	160	120
	350	2900 K	3000 K	3090 K	160	120

- ProLight maintains a tolerance of $\pm 5\%$ for CCT measurements.

Electro-Optical Characteristics, $T_j = 25^\circ\text{C}$

I_F (mA)	V_F (V)	Power (W)	PDSQ-17FVL-D2030	
			Flux (lm)	lm/W
50	31.42	1.57	121.4	77.3
100	33.13	3.31	287.0	86.6
200	34.94	6.99	629.8	90.1
350	37.00	12.95	1100.0	84.9
420	37.85	15.90	1301.1	81.9

● All values are reference only.

Absolute Maximum Ratings

Parameter	Warm White
Max DC Forward Current (mA)	420
Peak Pulsed Forward Current (mA)	630 (less than 1/10 duty cycle@1KHz)
ESD Sensitivity (HBM per MIL-STD-883E Method 3015.7)	$\pm 2000\text{V}$
LED Junction Temperature	120°C
Operating Board Temperature at Maximum DC Forward Current	$-40^\circ\text{C} - 90^\circ\text{C}$
Storage Temperature	$-40^\circ\text{C} - 120^\circ\text{C}$
Reverse Voltage	Not designed to be driven in reverse bias

Color Bin

Warm White Binning Structure Graphical Representation

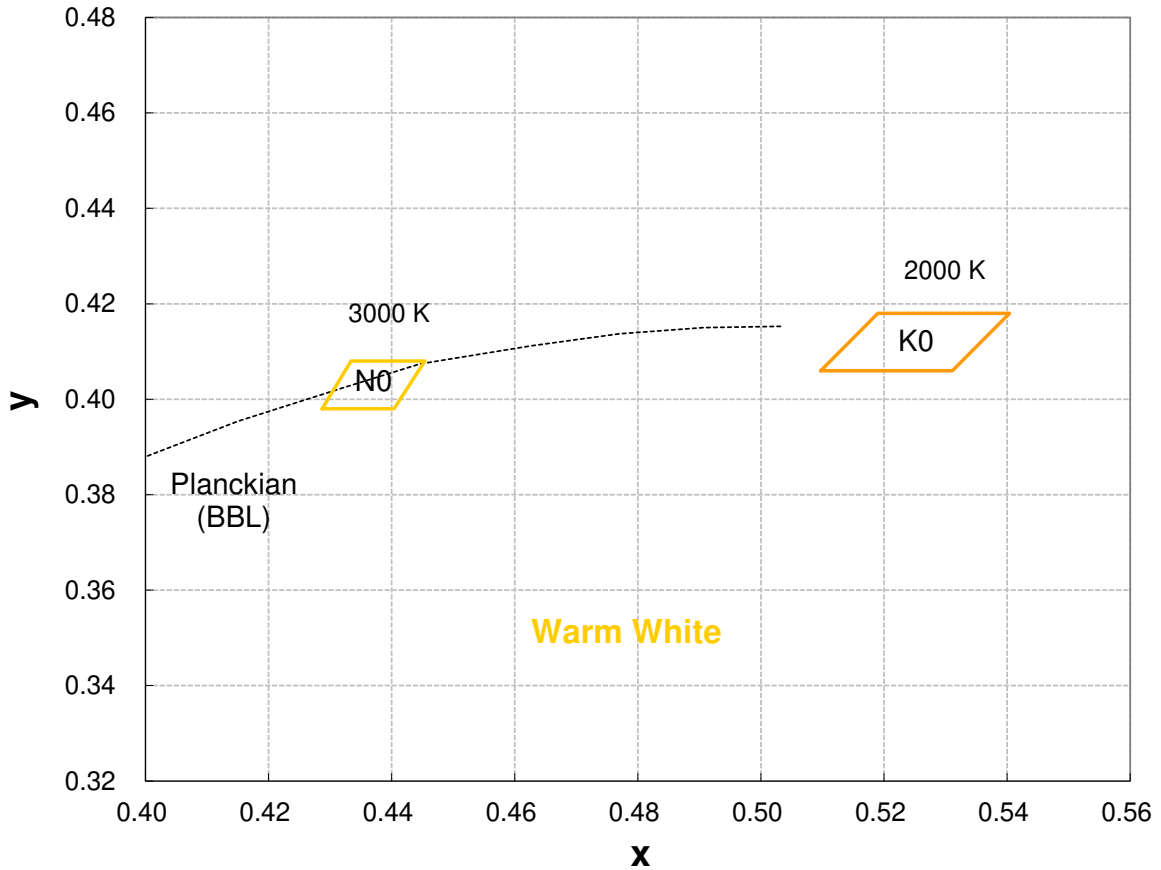

Warm White Bin Structure

Bin Code	x	y	Typ. CCT (K)	Bin Code	x	y	Typ. CCT (K)
K0	0.5097	0.4060	2000	N0	0.4287	0.3980	3000
	0.5311	0.4060			0.4404	0.3980	
	0.5404	0.4180			0.4454	0.4080	
	0.5190	0.4180			0.4334	0.4080	

- Tolerance on each color bin (x , y) is ± 0.005

Color Spectrum, $T_c = 25^\circ\text{C}$

1. Dual Color : 2000K~3000K

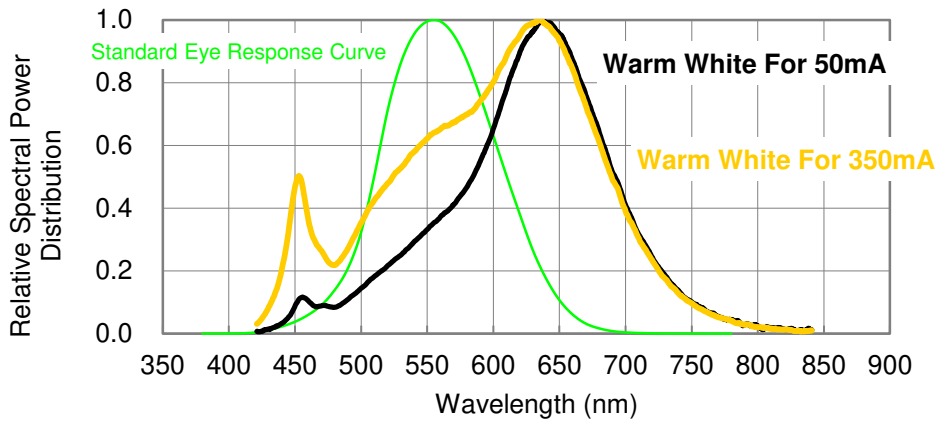

Forward Current Relative Characteristics

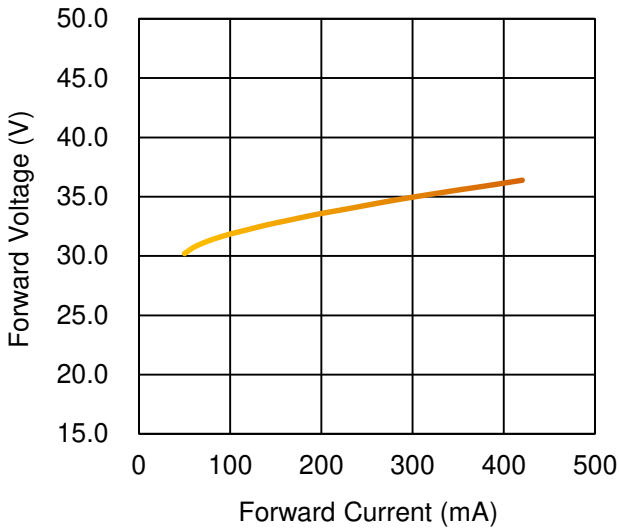

Fig 5. Forward Current vs. Forward Voltage at $T_C=25^\circ\text{C}$.

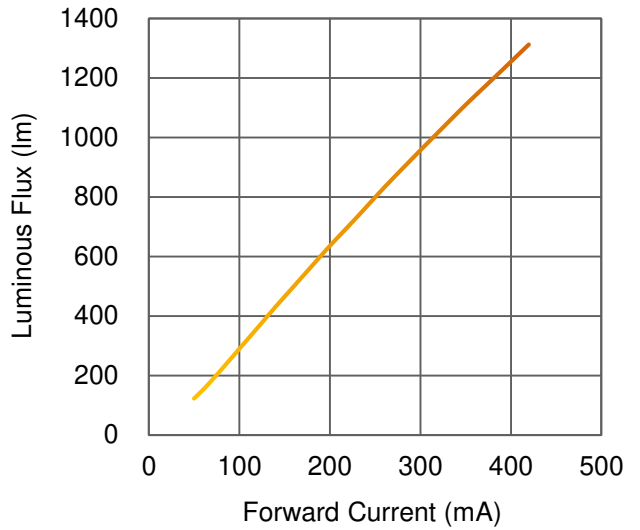

Fig 6. Forward Current vs. Relative Luminous Flux at $T_C=25^\circ\text{C}$.

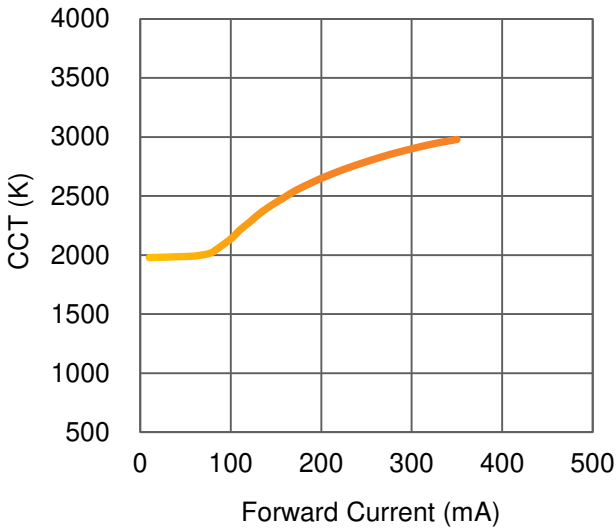

Fig 7. Forward Current vs. Color Temperature at $T_C=25^\circ\text{C}$.

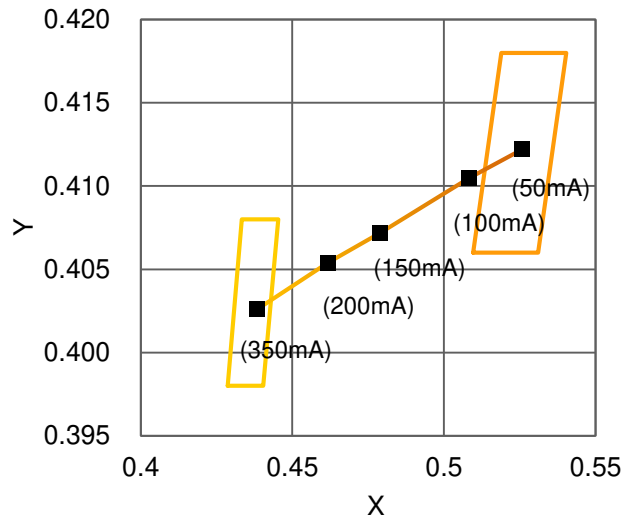

Fig 8. Chromaticity Coordinate Profile at $T_C=25^\circ\text{C}$.

Case Temperature Relative Characteristics

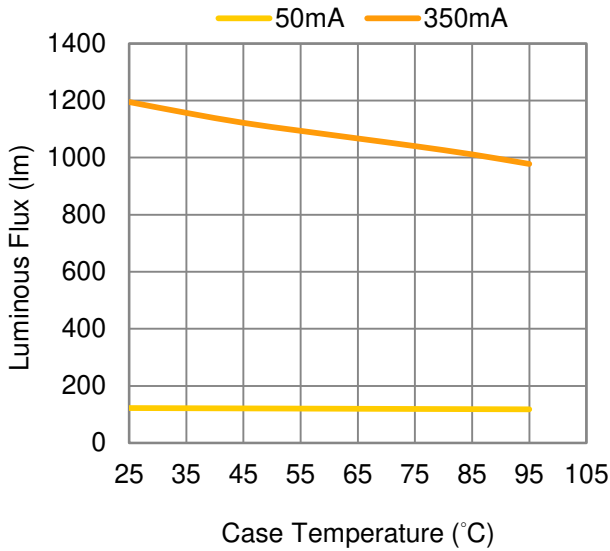

Fig 1. Case Temperature vs. Luminous Flux at 50 mA & 350 mA.

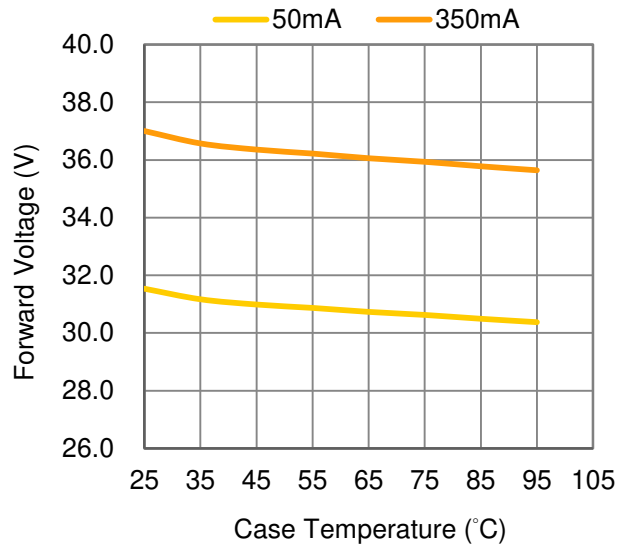

Fig 2. Case Temperature vs. Forward Voltage at 50 mA & 350 mA.

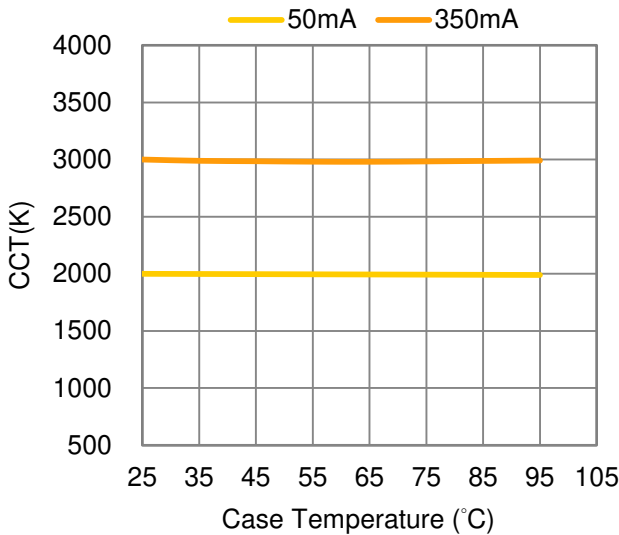

Fig 3. Case Temperature vs. Chromaticity Coordinate Δx at 50 mA & 350mA.

Case Temperature vs. Junction Temperature Characteristics

T _c (°C)	T _j (°C)
	350 (mA)
0	51
5	56
10	61
15	66
20	71
25	76
30	81
35	86
40	91
45	96
50	101
55	106
60	111
65	116
70	121

Fig 9. Case Temperature vs. Junction Temperature at 350mA.

Typical Representative Spatial Radiation Pattern

Lambertian Radiation Pattern

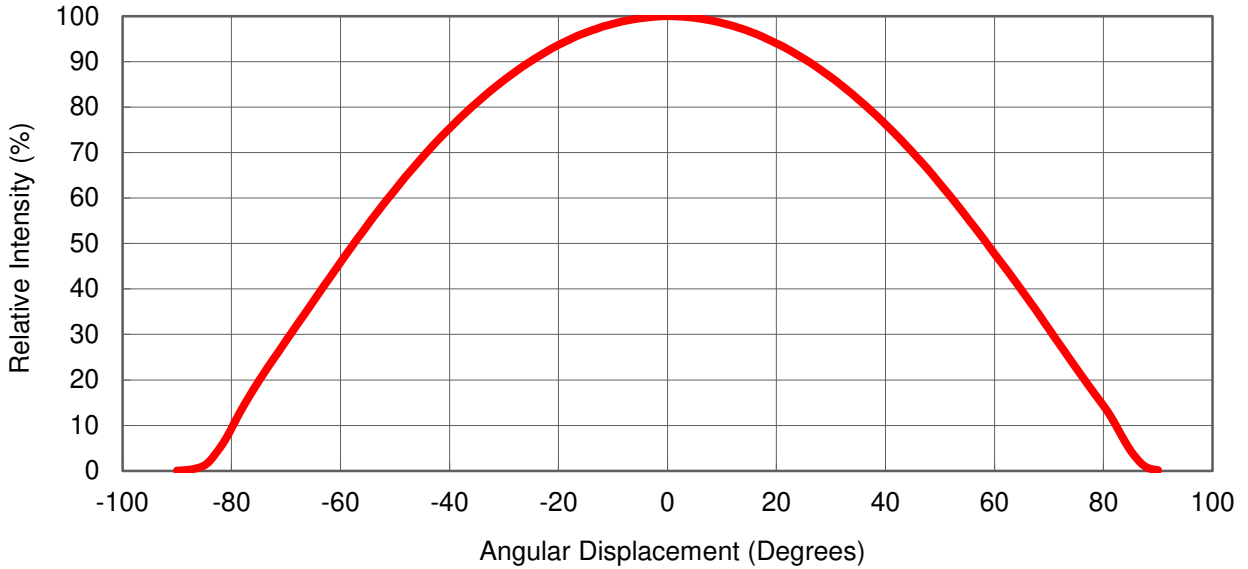

Polar Radiation Pattern

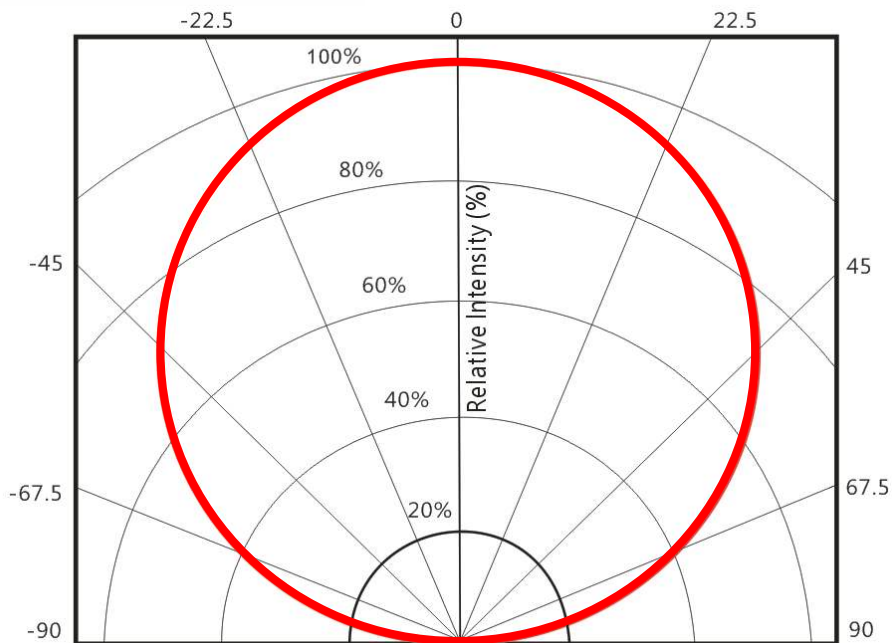

Packing Specifications

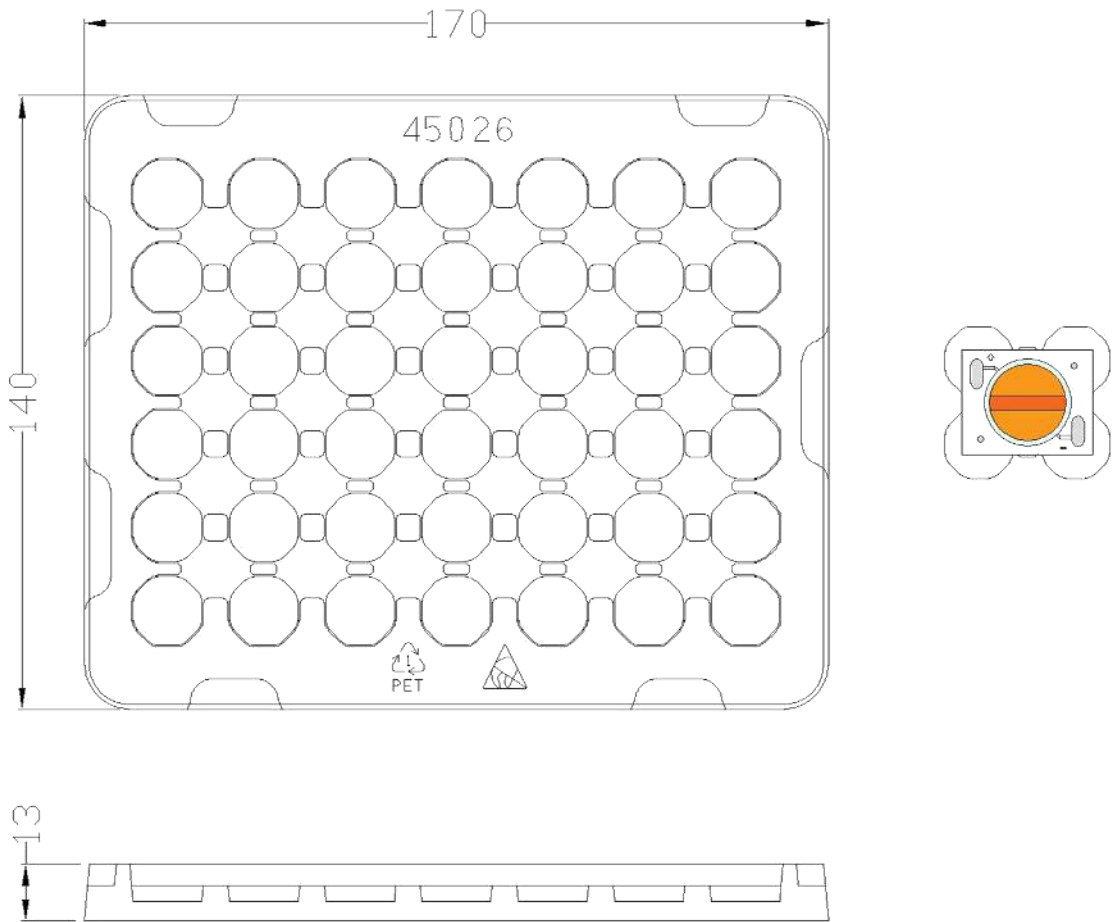

Product 30 pcs/tray

Notes:

1. Drawing not to scale.
2. All dimensions are in millimeters.
3. Unless otherwise indicated, tolerances are $\pm 0.20\text{mm}$.

Recommended Soldering Condition

- Please use lead free and “no clean ” solders.
- Soldering shall be implemented using a soldering tip at a temperature lower than 350 °C, and shall be finished within 3.5 seconds for each pad.
- During the soldering process, put the LEDs on materials whose conductivity is poor enough not to radiate heat of soldering.
- Properly solder tin wires before soldering them to LEDs.
- Avoid touching the silicone lens with the soldering iron.
- Please prevent flux from touching to the silicone lens.
- Please solder evenly on each pad.
- Contacts number of a soldering tip should be within twice for each pad.
- Next process of soldering should be carried out after the LEDs have return to ambient temperature.

*ProLight cannot guarantee if usage exceeds these recommended conditions.

Please use it after sufficient verification is carried out on your own risk if absolutely necessary.

Precaution for Use

- The modules light output are intense enough to cause injury to human eyes if viewed directly. Precautions must be taken to avoid looking directly at the modules with unprotected eyes.
- The modules are sensitive to electrostatic discharge. Appropriate ESD protection measures must be taken when working with the modules. Non-compliance with ESD protection measures may lead to damage or destruction of the product.
- Chemical solvents or cleaning agents must not be used to clean the modules. Mechanical stress on the Emitters must be avoided. It is best to use a soft brush, damp cloth or low-pressure compressed air.
- The products should be stored away from direct light in dry location.
- The appearance, specifications and flux bin of the product may be modified for improvement without notice. Please refer to the below website for the latest datasheets.
<http://www.prolightopto.com/>

Handling of Silicone Lens LEDs

Notes for handling of silicone lens LEDs

- Please do not use a force of over 0.3kgf impact or pressure on the silicone lens, otherwise it will cause a catastrophic failure.
- Avoid touching the silicone lens and the optical area of the COB Array especially by sharp tools such as Tweezers
- Avoid touching the silicone lens especially by sharp tools such as Tweezers.
- Avoid leaving fingerprints on the silicone lens.
- Please store the LEDs away from dusty areas or seal the product against dust.
- Please do not mold over the silicone lens with another resin. (epoxy, urethane, etc)

