

VL2-2W Series

2W Unregulated Single & Dual output

Features

- 7 Pin SIL Package
- 5200 VDC High Isolation
- Low Ripple and Noise
- Efficiency up to 85%
- Long Term Short Circuit Protection
- -40 ~ 95°C Operation Temperature Range
- Rated working voltage for 250Vrms and 400Vdc
- Low coupling capacitance
- Dedicated for IGBT applications



The VL2 series is a family of cost effective 2W single & dual output DC-DC converters. These converters achieve low cost and miniature SIP size without compromising performance. Devices are encapsulated with flame retardant resin. Input voltages are 5V, 12V, 15V, 24Vdc. with output voltage of 3.3V, 5V, 9V, 12V, 15V, ±5V, ±9V, ±12V, ±15V, +15V/-9Vdc. Special featuring long term output short circuit protection. Standard features include an input range of ±10% tolerance and low output noise and ripple.

All specifications typical at Ta=25°C, nominal input voltage and full load unless otherwise specified

OUTPUT SPECIFICATIONS		PHYSICAL SPECIFICATIONS	
Voltage Accuracy	±5%, max.	Case Material	Non-conductive Black Plastic(UL94V-0 rated)
Output Current	See table, max.	Pin Material	C5191R-H Solder-coated
Line Regulation	±1.2% / Per 1% Vin Change, max.	Potting Material	Epoxy (UL94V-0 rated)
Load Regulation (From 20% to 100% Load)	(VL2-053R3SS & VL2-0505SS) ±12%, max. (other models) ±10%, max.	Weight	2.7g
Cross Regulation (Dual Output) (1)	±5%, typ.	Dimensions	0.76"x0.28"x0.39"
Ripple & Noise (20 MHz bandwidth) (2)	150mVpk-pk, max.	ENVIRONMENT SPECIFICATIONS	
Short Circuit Protection	Indefinite (Automatic Recovery)	Operating Temperature	-40°C ~ +95°C (See Derating Curve) -40°C ~ +65°C (For 100% load)
Temperature Coefficient	±0.03%/°C	Maximum Case Temperature	100°C
Capacitor Load (3)	See table, max.	Storage Temperature	-55°C ~ +125°C
		Cooling (5)	Nature Convection
INPUT SPECIFICATIONS		ABSOLUTE MAXIMUM RATINGS (6)	
Input Voltage Range	±10%, max.	These are stress ratings. Exposure of devices to any of these conditions may adversely affect long-term reliability.	
Input Current (No-Load)	See table, max.	Input Surge Voltage (1000mS)	
Input Current (Full-Load)	See table, typ.	5 Models	9 Vdc, max.
Input Filter	Capacitor	12 Models	18 Vdc, max.
Input Reflected Ripple Current (4)	20mApk-pk, typ.	15 Models	20 Vdc, max.
Start up Time	20mS, typ.	24 Models	30 Vdc, max.
(Nominal Vin and constant resistive load)		Soldering Temperature	260°C, max.
		(1.5mm from case 10sec max.)	
GENERAL SPECIFICATIONS		EMC SPECIFICATIONS	
Efficiency	See table, typ.	Conducted Emissions (7)	EN55032 CLASS B
I/O Isolation Voltage (60sec)	5200Vdc	Radiated Emissions	EN55032 CLASS B
I/O Isolation Resistance	1000M Ohm, min.	ESD	IEC 61000-4-2 Perf. Criteria A
I/O Isolation Capacitance	7 pF, typ.	RS	IEC 61000-4-3 Perf. Criteria A
Switching Frequency	50~100kHz, typ.	EFT (8)	IEC 61000-4-4 Perf. Criteria A
Humidity	95% rel H	Surge (8)	IEC 61000-4-5 Perf. Criteria A
Reliability Calculated MTBF (MIL-HDBK-217 F)	>3.3Mhrs	CS	IEC 61000-4-6 Perf. Criteria A
Safety Standard (designed to meet)	IEC/EN 60950-1	PFMF	IEC 61000-4-8 Perf. Criteria A

The information and specifications contained in this data sheet are believed to be correct at time of publication. However, MOTIEN Technologies accepts no responsibility for consequences arising from printing errors or inaccuracies. Specifications are subject to change without notice. No rights under any patent accompany the sale of any such product(s) or information contained herein.

VL2 2W Unregulated Single & Dual output

PART NUMBER STRUCTURE

VL2 - 12 15 SS

Series Name

Input Voltage

05 - 5V
12 - 12V
15 - 15V
24 - 24V

Output Type

SS - Single output
S - Dual Output

Output Voltage

3R3 - 3.3V
05 - 5V
09 - 9V
12 - 12V
15 - 15V

VL2 - 12 15 09 S

Series Name

Input Voltage

05 - 5V
12 - 12V
15 - 15V
24 - 24V

- Output Voltage

09 - -9V

+ Output Voltage

15 - 15V

Output Type
S - Dual Output

MODEL SELECTION GUIDE

MODEL NUMBER	INPUT Voltage Range (Vdc)	INPUT Current		OUTPUT Voltage (Vdc)	OUTPUT Current Full load (mA)	EFFICIENCY @FL (% , typ.)	Capacitor Load @FL (µF, max.)
		No-Load (mA, max.)	Full Load (mA, typ.)				
VL2-053R3SS	5 (4.5 ~ 5.5)	40	435	3.3	500	76	1000
VL2-0505SS	5 (4.5 ~ 5.5)	40	507	5	400	79	470
VL2-0509SS	5 (4.5 ~ 5.5)	40	482	9	222	83	470
VL2-0512SS	5 (4.5 ~ 5.5)	40	477	12	167	84	220
VL2-0515SS	5 (4.5 ~ 5.5)	40	471	15	133	85	220
VL2-123R3SS	12 (10.8 ~ 13.2)	30	186	3.3	500	74	1000
VL2-1205SS	12 (10.8 ~ 13.2)	30	211	5	400	79	470
VL2-1209SS	12 (10.8 ~ 13.2)	30	204	9	222	82	470
VL2-1212SS	12 (10.8 ~ 13.2)	30	204	12	167	82	220
VL2-1215SS	12 (10.8 ~ 13.2)	30	201	15	133	83	220
VL2-153R3SS	15 (13.5 ~ 16.5)	25	149	3.3	500	74	1000
VL2-1505SS	15 (13.5 ~ 16.5)	25	171	5	400	78	470
VL2-1509SS	15 (13.5 ~ 16.5)	25	165	9	222	81	470
VL2-1512SS	15 (13.5 ~ 16.5)	25	163	12	167	82	220
VL2-1515SS	15 (13.5 ~ 16.5)	25	161	15	133	83	220
VL2-243R3SS	24 (21.6 ~ 26.4)	20	95	3.3	500	73	1000
VL2-2405SS	24 (21.6 ~ 26.4)	20	107	5	400	78	470
VL2-2409SS	24 (21.6 ~ 26.4)	20	103	9	222	81	470
VL2-2412SS	24 (21.6 ~ 26.4)	20	103	12	167	81	220
VL2-2415SS	24 (21.6 ~ 26.4)	20	103	15	133	81	220
VL2-0505S	5 (4.5 ~ 5.5)	40	507	±5	±200	79	±220
VL2-0509S	5 (4.5 ~ 5.5)	40	488	±9	±111	82	±220
VL2-0512S	5 (4.5 ~ 5.5)	40	482	±12	±83.3	83	±100
VL2-0515S	5 (4.5 ~ 5.5)	40	477	±15	±66.7	84	±100
VL2-051509S	5 (4.5 ~ 5.5)	40	482	+15/-9	+66.7/-111	83	+100/-220
VL2-1205S	12 (10.8 ~ 13.2)	30	211	±5	±200	79	±220
VL2-1209S	12 (10.8 ~ 13.2)	30	206	±9	±111	81	±220
VL2-1212S	12 (10.8 ~ 13.2)	30	201	±12	±83.3	83	±100
VL2-1215S	12 (10.8 ~ 13.2)	30	201	±15	±66.7	83	±100
VL2-121509S	12 (10.8 ~ 13.2)	30	209	+15/-9	+66.7/-111	80	+100/-220
VL2-1505S	15 (13.5 ~ 16.5)	25	169	±5	±200	79	±220
VL2-1509S	15 (13.5 ~ 16.5)	25	165	±9	±111	81	±220
VL2-1512S	15 (13.5 ~ 16.5)	25	161	±12	±83.3	83	±100
VL2-1515S	15 (13.5 ~ 16.5)	25	163	±15	±66.7	82	±100
VL2-151509S	15 (13.5 ~ 16.5)	25	165	+15/-9	+66.7/-111	81	+100/-220
VL2-2405S	24 (21.6 ~ 26.4)	20	106	±5	±200	79	±220
VL2-2409S	24 (21.6 ~ 26.4)	20	105	±9	±111	80	±220
VL2-2412S	24 (21.6 ~ 26.4)	20	103	±12	±83.3	81	±100
VL2-2415S	24 (21.6 ~ 26.4)	20	102	±15	±66.7	82	±100
VL2-241509S	24 (21.6 ~ 26.4)	20	105	+15/-9	+66.7/-111	80	+100/-220

The models listed above is just for standard type. If you need the special specification product, please contact our service member by telephone presented in shortform cover or e-mail to : sales@motien.com.tw

NOTE

1. One load is 25% to 100% load, the other load is 100% load, the output voltage variable rate is within $\pm 5\%$.
2. Ripple/Noise measured with a $10\mu\text{F}$ electrolytic capacitor and $0.1\mu\text{F}$ ceramic capacitor.
3. Tested by minimal V_{in} and constant resistive load.
4. Measured Input reflected ripple current with a simulated source inductance of $12\mu\text{H}$ And a source capacitor C_{in} ($47\mu\text{F}$, $\text{ESR} < 1.0\Omega$ at 100kHz).
5. "Nature Convection" is usually about 30-65 LFM but is not equal to still air (0 LFM).
6. Exceeding the absolute ratings of the unit could cause damage. It is not allowed for continuous operating.
7. The VL2 series standard module meets EMI ClassB with external components. For more detail information, please contact with Motien.
8. Input components (C1,D1) are used to help meet surge test requirement for the module. C1 and D1 recommended nichicon UHE series and Littelfuse SMDJ series.
9. Operation under no-load conditions will not damage these devices, however they may not meet all listed specifications.

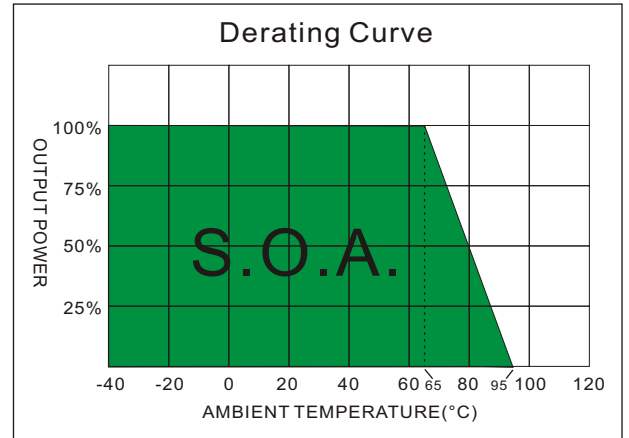

TEST CONFIGURATIONS

Input Reflected Ripple Current Test Step

Input reflected ripple current is measured through a source inductor L_{in} ($12\mu\text{H}$) and a source capacitor C_{in} ($47\mu\text{F}$, $\text{ESR} < 1.0\Omega$ at 100kHz) at nominal input and full load.

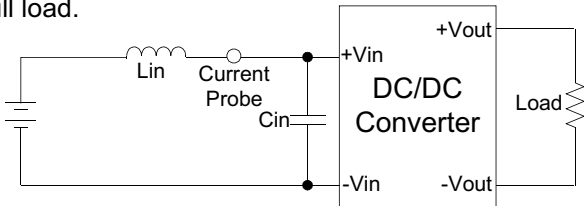

Output Ripple & Noise Measurement Test

Use a $10\mu\text{F}$ electrolytic capacitor and $0.1\mu\text{F}$ ceramic capacitor. The Scope measurement bandwidth is 0-20MHz.

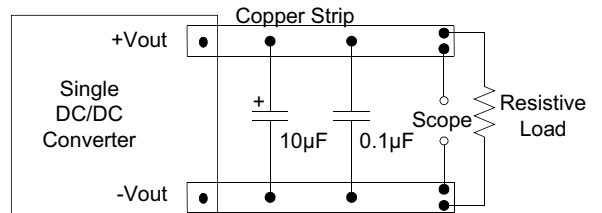

EFT & SURGE Filter

Input components (C1,D1) are used to help meet surge test requirement for the module.

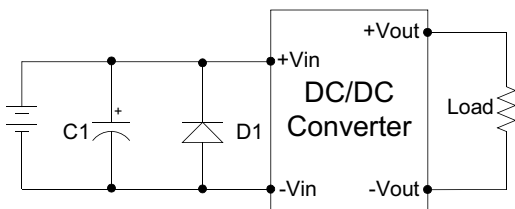

	C1	D1
VL2-05XXXX	330µF/50V	SMDJ9.0A
VL2-12XXXX	330µF/50V	SMDJ13A
VL2-15XXXX	330µF/50V	SMDJ18A
VL2-24XXXX	1000µF/35V	SMDJ24A

D1: Transient Voltage Suppression Diodes

EMI Filter

Input filter components (C1,C2,C3,L) are used to help meet conducted emissions requirement for the module. These components should be mounted as close as possible to the module; and all leads should be minimized to decrease radiated noise.

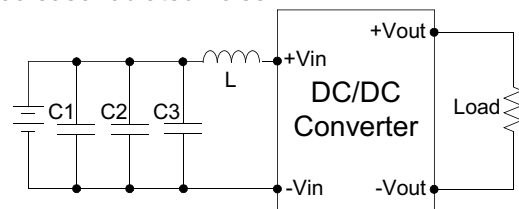

	C1	C2	C3	L
VL2-05XXXX	1206,4.7µF/16V	X	X	6.8µH
VL2-12XXXX	1206,22µF/25V	X	X	6.8µH
VL2-15XXXX	1206,22µF/25V	X	X	6.8µH
VL2-24XXXX	1210,10µF/35V	1210,10µF/35V	1210,10µF/35V	10µH

MECHANICAL SPECIFICATIONS

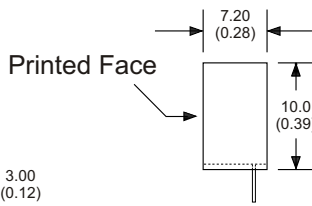
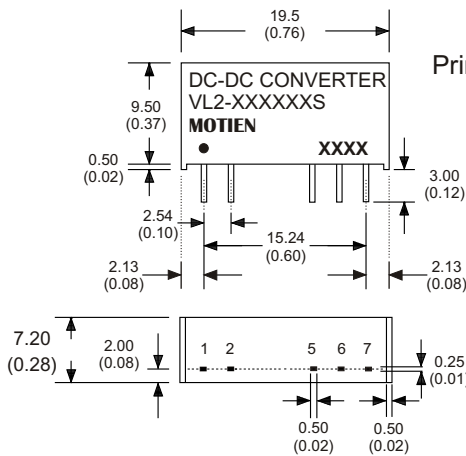

7 Pin SIL Package

- Notes : All dimensions are typical in millimeters (inches).
1. Pin diameter: 0.5 ± 0.05 (0.02 ± 0.002)
 2. Pin pitch and length tolerance: ± 0.35 (± 0.014)
 3. Pin to case tolerance: ± 0.5 (± 0.02)
 4. Case Tolerance: ± 0.5 (± 0.02)

PIN CONNECTIONS		
PIN NUMBER	SINGLE	DUAL
1	+V Input	+V Input
2	-V Input	-V Input
5	-V Output	-V Output
6	N.P.	Common
7	+V Output	+V Output