

# VE-2W Series

2W Unregulated Single output

## Features

- 4 Pin SIL Package
- 1000 VDC Isolation
- Up to 3000 VDC Isolation
- Low Ripple and Noise
- Efficiency up to 88%
- -40 ~ 85°C Operation Temperature Range
- Non-Conductive Black Plastic Case
- EMI Complies With EN55032 Class B



The VE series is a family of cost effective 2W single output DC-DC converters. These converters achieve low cost and ultra-miniature SIP 4 pin size. Devices are encapsulated using flame retardant resin. The models operate from input voltage of 5, 12, 15, 24, 48 Vdc with output voltage of 3.3, 5, 7.2, 9, 12, 15, 24 Vdc. High performance features include 1000Vdc~3000Vdc input/output isolation, high efficiency operation and output voltage accuracy of  $\pm 3\%$  maximum. Standard features include an input range of  $\pm 10\%$  tolerance and low output noise and ripple.

All specifications typical at Ta=25°C, nominal input voltage and full load unless otherwise specified

OUTPUT SPECIFICATIONS		ABSOLUTE MAXIMUM RATINGS <sup>(4)</sup>	
Output Voltage accuracy	$\pm 3\%$ ,max.	These are stress ratings. Exposure of devices to any of these conditions may adversely affect long-term reliability.	
Line regulation	$\pm 1.2\%$ / Per 1% Vin Change	Input Surge Voltage(100mS)	
Load regulation	(From 20% to 100% Load) $\pm 10\%$ ,max. (Output 3.3V Model) $\pm 20\%$ ,max.	5 Models	7 Vdc ,max.
Ripple & noise (20 MHz bandwidth) <sup>(1)</sup>	150mVpk-pk ,max.	12 Models	15 Vdc ,max.
Temperature coefficient	$\pm 0.02\%/^{\circ}\text{C}$	15 Models	18 Vdc ,max.
Capacitor load <sup>(2)</sup>	See table ,max.	24 Models	28 Vdc ,max.
		48 Models	54 Vdc ,max.
		Soldering Temperature	260°C ,max. (1.5mm from case 10sec max.)
INPUT SPECIFICATIONS		GENERAL SPECIFICATIONS	
Input Voltage Range	$\pm 10\%$	Efficiency	See table
Input Current	See table ,typ.	I/O Isolation Voltage <sup>(60sec)</sup>	
Input Current(No-Load)	See table ,max.	Input/Output	1000~3000Vdc
Input Filter	Capacitors	I/O Isolation Capacitance	60 pF Typ.
Input Reflected Ripple Current <sup>(3)</sup>	20mApk-pk ,typ.	I/O Isolation Resistance	1000M Ohm
		Switching Frequency	Variable 70kHz
		Humidity	95% rel H
		Reliability Calculated MTBF(MIL-HDBK-217 F)	>1.121Mhrs
		Safety Standard : (designed to meet)	IEC 60950-1
PHYSICAL SPECIFICATIONS		EMC SPECIFICATIONS	
Case Material	Non-conductive Black Plastic(UL94V-0 rated)	Radiated Emissions	EN55032 CLASS B
Pin Material	0.5mm Alloy42 Solder-coated	Conducted Emissions <sup>(6)</sup>	EN55032 CLASS B
Potting Material	Epoxy (UL94V-0 rated)	ESD	IEC 61000-4-2 Perf. Criteria A
Weight	1.9g	RS	IEC 61000-4-3 Perf. Criteria A
Dimensions	0.46"x0.29"x0.40"	EFT <sup>(7)</sup>	IEC 61000-4-4 Perf. Criteria A
		Surge <sup>(7)</sup>	IEC 61000-4-5 Perf. Criteria A
		CS	IEC 61000-4-6 Perf. Criteria A
		PFMF	IEC 61000-4-8 Perf. Criteria A
ENVIRONMENT SPECIFICATIONS			
Operating Temperature	-40°C~85°C		
Maximum Case Temperature	100°C		
Storage Temperature	-40°C~125°C		
Cooling	Nature Convection		

The information and specifications contained in this data sheet are believed to be correct at time of publication. However, MOTIEN Technologies accepts no responsibility for consequences arising from printing errors or inaccuracies. Specifications are subject to change without notice. No rights under any patent accompany the sale of any such product(s) or information contained herein.

## VE - 2W Unregulated Single output

### PART NUMBER STRUCTURE

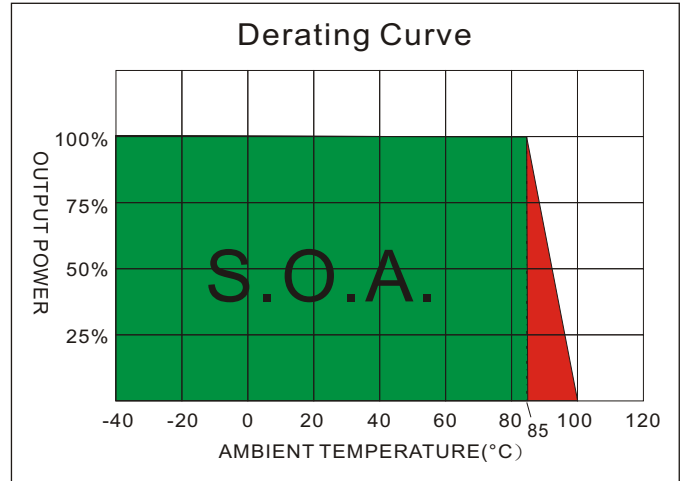
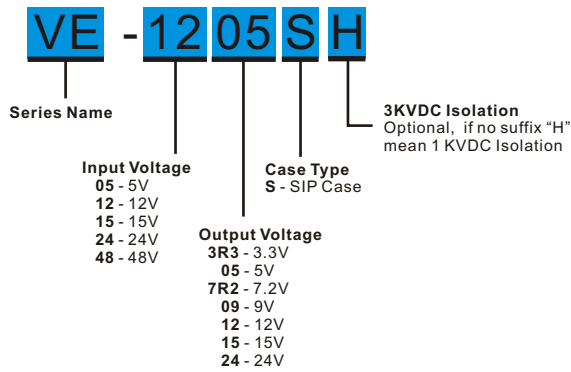

## MODEL SELECTION GUIDE

MODEL NUMBER	INPUT Voltage Range (Vdc)	INPUT Current		OUTPUT Voltage (Vdc)	OUTPUT Current Full load (mA)	EFFICIENCY @FL (% , typ.)	Capacitor Load @FL (µF, max.)
		No-Load (mA, max.)	Full Load (mA, typ.)				
VE-053R3S	5	32	338	3.3	400	78	470
VE-0505S	5	30	494	5	400	81	470
VE-057R2S	5	40	500	7.2	278	80	470
VE-0509S	5	30	482	9	222	83	470
VE-0512S	5	38	476	12	167	84	470
VE-0515S	5	35	471	15	133	85	470
VE-0524S	5	35	465	24	83	86	470
VE-123R3S	12	20	152	3.3	400	72	470
VE-1205S	12	25	206	5	400	81	470
VE-127R2S	12	20	208	7.2	278	80	470
VE-1209S	12	23	200	9	222	83	470
VE-1212S	12	20	196	12	167	85	470
VE-1215S	12	20	196	15	133	85	470
VE-1224S	12	30	196	24	83	85	470
VE-153R3S	15	25	116	3.3	400	76	470
VE-1505S	15	20	165	5	400	81	470
VE-157R2S	15	20	161	7.2	278	83	470
VE-1509S	15	20	167	9	222	80	470
VE-1512S	15	20	158	12	167	84	470
VE-1515S	15	15	155	15	133	86	470
VE-1524S	15	20	159	24	83	84	470
VE-243R3S	24	7	68	3.3	400	81	470
VE-2405S	24	9	100	5	400	83	470
VE-247R2S	24	12	102	7.2	278	82	470
VE-2409S	24	10	98	9	222	85	470
VE-2412S	24	12	97	12	167	86	470
VE-2415S	24	8	97	15	133	86	470
VE-2424S	24	10	95	24	83	88	470
VE-483R3S	48	10	37	3.3	400	74	470
VE-4805S	48	5	53	5	400	79	470
VE-487R2S	48	8	50	7.2	278	83	470
VE-4809S	48	5	50	9	222	83	470

Suffix "H" means 3 KVdc isolation

The models listed above is just for standard type. If you need the special specification product, please contact our service member by telephone presented in shortform cover or e-mail to : sales@motien.com.tw

## VE - 2W Unregulated Single output

MODEL NUMBER	INPUT Voltage Range (Vdc)	INPUT Current		OUTPUT Voltage (Vdc)	OUTPUT Current Full load (mA)	EFFICIENCY @FL (% , typ.)	Capacitor Load @FL (µF, max.)
		No-Load (mA, max.)	Full Load (mA, typ.)				
VE-4812S	48	5	51	12	167	81	470
VE-4815S	48	7	51	15	133	82	470
VE-4824S	48	6	48	24	83	86	470

Suffix "H" means 3 KVdc isolation

### TEST CONFIGURATIONS

#### EMI Filter

Input filter components (C1, L, C2, C3) are used to help meet conducted emissions requirement for the module. These components should be mounted as close as possible to the module; and all leads should be minimized to decrease radiated noise.

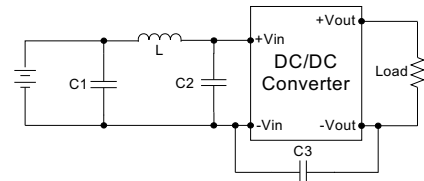

	C1	L	C2	C3
VE-05XXXX	1210, 2.2µF/100V	18µH		
VE-12XXXX	1210, 2.2µF/100V	18µH		
VE-15XXXX	1210, 2.2µF/100V	18µH		
VE-24XXXX	1210, 2.2µF/100V	18µH	1210, 2.2µF/100V	1206, 470pF/2KV
VE-48XXXX	Electrolytic Capacitor, 10µF/100V	18µH	1210, 2.2µF/100V	1206, 470pF/2KV

### NOTE

1. Ripple/Noise measured with 20MHz bandwidth.
2. Tested by minimal Vin and constant resistive load.
3. Measured Input reflected ripple current with a simulated source inductance of 12µH and a source capacitor Cin(47µF, ESR<1.0Ω at 100KHz).
4. Exceeding the absolute ratings of the unit could cause damage. It is not allowed for continuous operating.
5. Operation under no-load conditions will not damage these devices, however they may not meet all listed specifications.
6. Input filter components are required to help meet conducted emission class B, which application refer to the EMI Filter of design & feature configuration.
7. An external filter capacitor is required if the module has to meet IEC61000-4-4 and IEC61000-4-5. The filter capacitor Motien suggest: Nippon - chemi - con KY series, 470µF/100V.

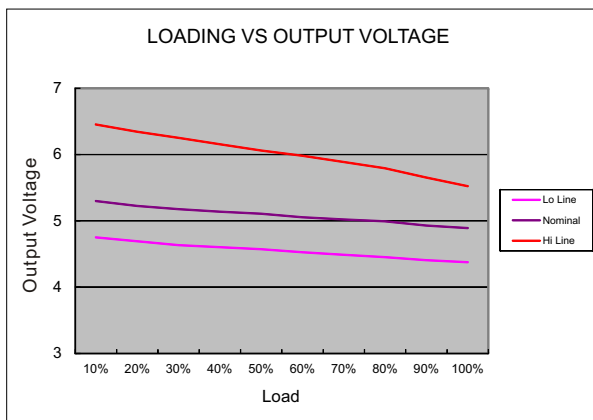

5 Models

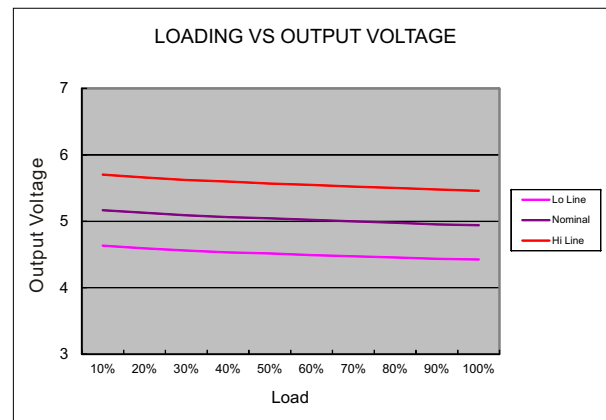

12 Models

The models listed above is just for standard type. If you need the special specification product, please contact our service member by telephone presented in shortform cover or e-mail to : sales@motien.com.tw

VE - 2W Unregulated Single output

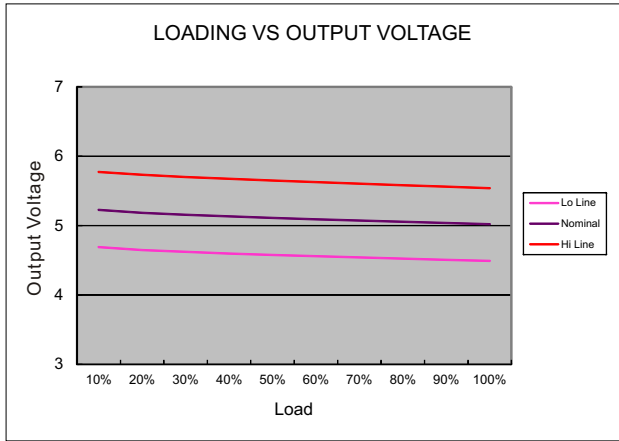

24 Models

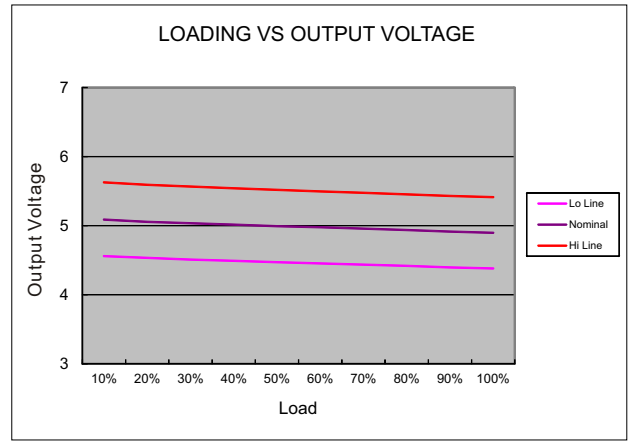

48 Models

MECHANICAL SPECIFICATIONS

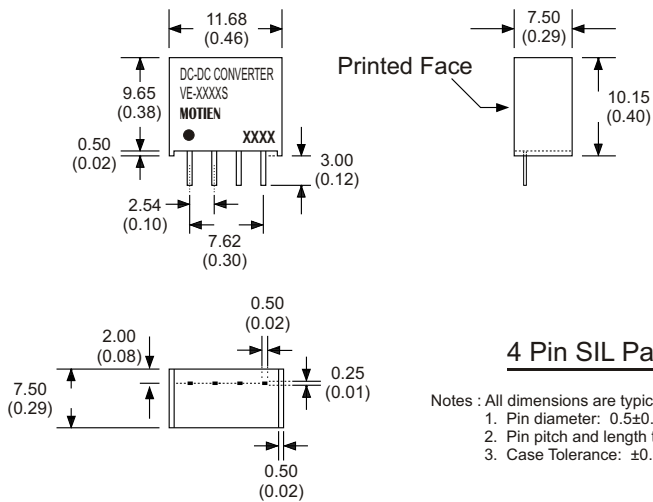

4 Pin SIL Package

- Notes : All dimensions are typical in millimeters ( inches ).
1. Pin diameter: 0.5±0.05 ( 0.02±0.002 )
  2. Pin pitch and length tolerance: ±0.35 ( ±0.014 )
  3. Case Tolerance: ±0.5 ( ±0.02 )

PIN CONNECTIONS	
PIN NUMBER	SINGLE
1	-V Input
2	+V Input
3	-V Output
4	+V Output

(The Pin Connection of high isolation one is the same with normal one.)