

# VB-6W Series

6W 2:1 Regulated Single & Dual output

## Features

- Highest Power Density In 8 Pin SIL Package
- Wide 2:1 Input Range
- Smallest Footprint 6W Converter
- No Minimum Load Required
- 1500 VDC Isolation , Up to 3000VDC
- Continuous Short Circuit Protection
- Efficiency up to 86%
- -40°C ~+ 65°C Operation Temperature Range
- Remote on/off Control (Optional)



The VB-6W series is a family of high performed 6W single & dual output DC-DC converters. These converters are built in non-conductive black plastic package in a 8-pin SIL miniature compact case with high performance features wide range devices operate over 2:1 input voltage range providing stable output voltage which is much smaller than package of DIL 24- Same power rating but only 43% of the traditional volume. Devices are encapsulated using flame retardant resin. Input voltages of 5, 12, 24, 48 with output voltage of 3.3, 5, 9, 12, 15, 24,  $\pm 5$ ,  $\pm 12$ ,  $\pm 15$  Vdc. Featuring new PFM construction, no minimum load required and precise 1% output voltage accuracy.

All specifications typical at Ta=25°C, nominal input voltage and full load unless otherwise specified

OUTPUT SPECIFICATIONS		PHYSICAL SPECIFICATIONS	
Voltage Accuracy	$\pm 1\%$	Case Material	Non conductive black plastic
Maximum Output Current	See table	Potting Material	Epoxy (UL94V-0 rated)
Line Regulation	$\pm 0.2\%$ max.	Pin Material	C5191R-H Solder-coated
Load Regulation	Single & Dual (From 0% to 100% Load) $\pm 1.0\%$ , max.	Weight	4.5g, typ.
Cross Regulation (Dual Output) (1)	$\pm 5\%$	Dimensions	0.86"x0.36"x0.44"
Ripple & Noise (20 MHz bandwidth)(2)	75mVpk-pk, max.	ENVIRONMENT SPECIFICATIONS	
Short Circuit Protection	Continuous (Automatic Recovery)	Operating Temperature	-40°C~65°C
Temperature Coefficient	$\pm 0.02\%/^{\circ}\text{C}$	Maximum Case Temperature	105°C
Capacitive Load(3)	See table	Storage Temperature	-55°C~125°C
Transient Recovery Time (4)	500 $\mu\text{s}$ , typ.	Cooling(6)	Nature Convection
Transient Response Deviation(4)	$\pm 3\%$ , max. Output 3.3V&5V : $\pm 5\%$ , max.	ABSOLUTE MAXIMUM RATINGS(7)	
INPUT SPECIFICATIONS		These are stress ratings. Exposure of devices to any of these conditions may adversely affect long-term reliability.	
Voltage Range	See table	Input Surge Voltage(100ms max)	
Start up Time(Nominal Vin and constant resistive load)	30mS, typ	05 Models	15Vdc, max.
Max. Input Current	See table	12 Models	25Vdc, max.
No-Load Input Current	See table	24 Models	50Vdc, max.
Input Filter	Capacitor	48 Models	100Vdc, max.
Input Reflected Ripple Current(5)	30mApk-pk, typ	Soldering Temperature	260°C, max.
Remote on/off		(1.5mm from case 10sec max.)	
ON:	Open or high impedance	EMC SPECIFICATIONS	
OFF:	2-4mA input current (via 1K $\Omega$ ).	Radiated Emissions	EN55032 CLASS A
Off stand by input current(Nominal Vin)	2.5mA, typ	Conducted Emissions (8)	EN55032 CLASS A
GENERAL SPECIFICATIONS		ESD	IEC 61000-4-2 Perf. Criteria A
Efficiency	See table, typ.	RS	IEC 61000-4-3 Perf. Criteria A
I/O Isolation Voltage (60sec)	1500~3000Vdc	EFT (9)	IEC 61000-4-4 Perf. Criteria A
I/O Isolation Capacity	50 pF, max.	Surge (9)	IEC 61000-4-5 Perf. Criteria A
I/O Isolation Resistance	1G Ohm, min.	CS	IEC 61000-4-6 Perf. Criteria A
Switching Frequency	100kHz, min.	PFMF	IEC 61000-4-8 Perf. Criteria A
Humidity	95%reIH		
Reliability Calculated MTBF (MIL-HDBK-217 F)	>770 Khrs		
Safety Standard	UL/cUL 60950-1 , 62368-1 IEC/EN 60950-1 , 62368-1		
Safety Approvals	UL/cUL 60950-1 , 62368-1 IEC/EN 60950-1 , 62368-1		

The information and specifications contained in this data sheet are believed to be correct at time of publication. However, MOTIEN Technologies accepts no responsibility for consequences arising from printing errors or inaccuracies. Specifications are subject to change without notice. No rights under any patent accompany the sale of any such product(s) or information contained herein.

## VB - 6W 2:1 Regulated Single & Dual output

### PART NUMBER STRUCTURE

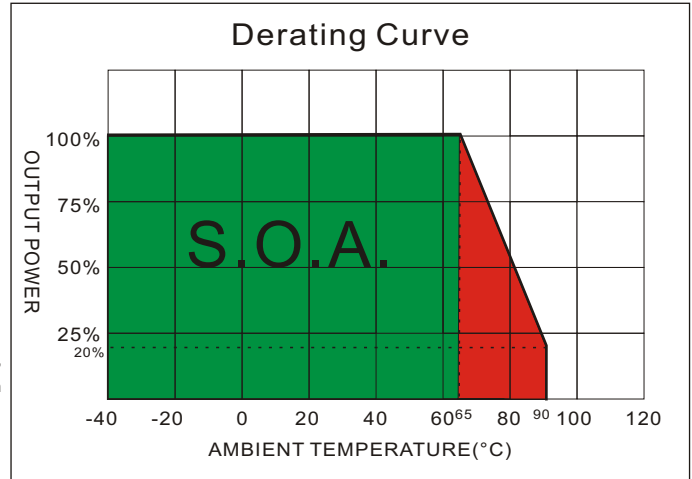
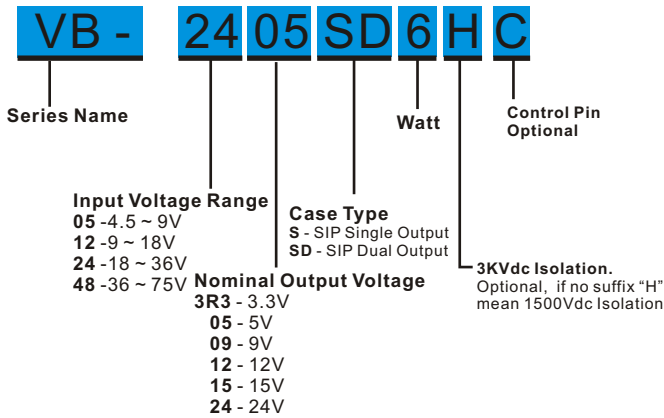

### MODEL SELECTION GUIDE

MODEL NUMBER	INPUT Voltage Range (Vdc)	INPUT Current		OUTPUT Voltage (Vdc)	OUTPUT Current		EFFICIENCY @FL(%)	Capacitor Load(uF)
		No-Load (mA)	Full Load (mA)		Min. load (mA)	Full load (mA)		
VB-053R3S6	4.5-9	105	1144	3.3	0	1300	75	6600uF
VB-0505S6	4.5-9	105	1519	5	0	1200	79	3300uF
VB-0509S6	4.5-9	105	1445	9	0	666	83	2000uF
VB-0512S6	4.5-9	105	1428	12	0	500	84	1600uF
VB-0515S6	4.5-9	105	1428	15	0	400	84	1400uF
VB-0524S6	4.5-9	105	1428	24	0	250	84	680uF
VB-0505SD6	4.5-9	105	1481	±5	0	±600	81	±2000uF
VB-0512SD6	4.5-9	105	1428	±12	0	±250	84	±900uF
VB-0515SD6	4.5-9	105	1428	±15	0	±200	84	±660uF
VB-123R3S6	9-18	55	470	3.3	0	1300	76	6600uF
VB-1205S6	9-18	55	602	5	0	1200	83	3300uF
VB-1209S6	9-18	55	595	9	0	666	84	2000uF
VB-1212S6	9-18	55	588	12	0	500	85	1600uF
VB-1215S6	9-18	55	588	15	0	400	85	1400uF
VB-1224S6	9-18	55	581	24	0	250	86	680uF
VB-1205SD6	9-18	55	609	±5	0	±600	82	±2000uF
VB-1212SD6	9-18	55	595	±12	0	±250	84	±900uF
VB-1215SD6	9-18	55	581	±15	0	±200	86	±660uF
VB-243R3S6	18-36	30	229	3.3	0	1300	78	6600uF
VB-2405S6	18-36	30	301	5	0	1200	83	3300uF
VB-2409S6	18-36	30	294	9	0	666	85	2000uF
VB-2412S6	18-36	30	294	12	0	500	85	1600uF
VB-2415S6	18-36	30	287	15	0	400	87	1400uF
VB-2424S6	18-36	30	287	24	0	250	87	680uF
VB-2405SD6	18-36	30	304	±5	0	±600	82	±2000uF
VB-2412SD6	18-36	30	297	±12	0	±250	84	±900uF
VB-2415SD6	18-36	30	297	±15	0	±200	84	±660uF
VB-483R3S6	36-75	15	117	3.3	0	1300	76	6600uF
VB-4805S6	36-75	15	156	5	0	1200	80	3300uF
VB-4809S6	36-75	15	147	9	0	666	85	2000uF
VB-4812S6	36-75	15	149	12	0	500	84	1600uF
VB-4815S6	36-75	15	145	15	0	400	86	1400uF
VB-4824S6	36-75	15	148	24	0	250	84	680uF
VB-4805SD6	36-75	15	152	±5	0	±600	82	±2000uF
VB-4812SD6	36-75	15	147	±12	0	±250	85	±900uF
VB-4815SD6	36-75	15	147	±15	0	±200	85	±660uF

Suffix "H" means 3KVdc isolation

Suffix "C" means with control pin

The models listed above is just for standard type. If you need the special specification product, please contact our service member by telephone presented in shortform cover or e-mail to : sales@motien.com.tw

**NOTE**

1. One load is 25% to 100% load, the other load is 100% load, the output voltage variable rate is within  $\pm 5\%$ .
2. Measured with a  $0.1\mu\text{F}$  ceramic capacitor and  $10\mu\text{F}$  Electrolytic capacitor.
3. Test by minimal  $V_{in}$  and constant resistive load.
4. Test by normal  $V_{in}$  and 100%-25% load, 25% load step change.
5. Measured Input reflected ripple current with a simulated source inductance of  $12\mu\text{H}$  and a source capacitor  $C_{in}(47\mu\text{F}, \text{ESR}<1.0\Omega \text{ at } 100\text{KHz})$ .
6. "Nature Convection" is usually about 30-65 LFM but is not equal to still air (0 LFM).
7. Exceeding the absolute ratings of the unit could cause damage. It's not allowed for continuous operating ratings
8. Input filter components are be required to help meet conducted emission class A, which application refer to the EMI Filter of design & feature configuration.
9. An external filter capacitor is required if the module has to meet IEC61000-4-4 and IEC61000-4-5.  
The filter capacitor Motien suggest: Nippon - chemi - con KY series,  $330\mu\text{F}/100\text{V}$ .

**TEST CONFIGURATIONS**

**Input Reflected Ripple Current Test Step**

Input reflected ripple current is measured through a source inductor  $L_{in}(12\mu\text{H})$  and a source capacitor  $C_{in}(47\mu\text{F}, \text{ESR}<1.0\Omega \text{ at } 100\text{KHz})$  at nominal input and full load.

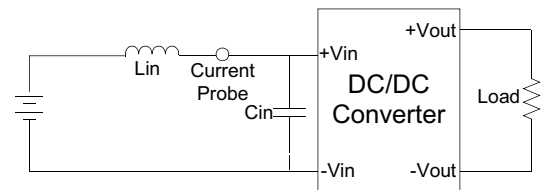

**Output Ripple & Noise Measurement Test**

Measured with a  $0.1\mu\text{F}$  MLCC capacitor and a  $10\mu\text{F}$  Electrolytic capacitor.  
The Scope measurement bandwidth is 0-20MHz.

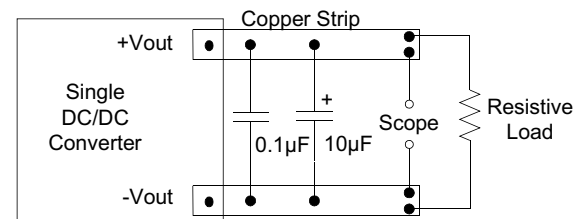

**CTRL Module ON / OFF**

ON: open or high impedance  
OFF: 2-4mA input current (via 1K)

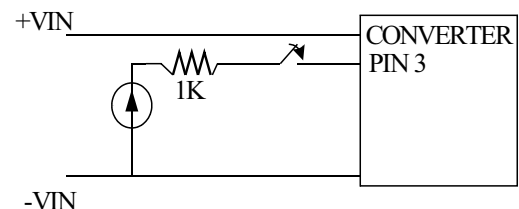

**EMI Filter**

Input filter components ( $C1, C2, C3, C4, C5, L$ ) are used to help meet conducted emissions requirement for the module. These components should be mounted as close as possible to the module; and all leads should be minimized to decrease radiated noise.

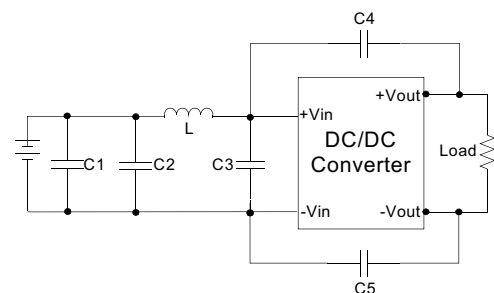

	C1	C2 & C3	L	C4 & C5
VB-05YYO6	Electrolytic capacitor, 220µF/100V	MLCC 22µF/25V	10µH	MLCC 220pF/3KV
VB-12YYO6		MLCC 10µF/50V	10µH	MLCC 220pF/3KV
VB-24YYO6		MLCC 10µF/50V	10µH	MLCC 220pF/3KV
VB-48YYO6		MLCC 2.2µF/100V	15µH	MLCC 220pF/3KV

# VB - 6W 2:1 Regulated Single & Dual output

## MECHANICAL SPECIFICATIONS

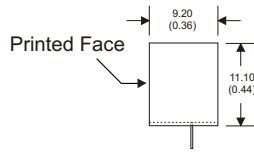
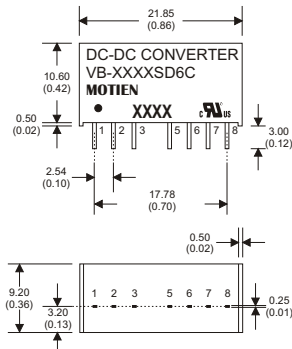

### 8 Pin SIL Package

- Notes : All dimensions are typical in millimeters ( inches ).
1. Pin diameter:  $0.5 \pm 0.05$  (  $0.02 \pm 0.002$  )
  2. Pin pitch and length tolerance:  $\pm 0.35$  (  $\pm 0.014$  )
  3. Pin to case tolerance:  $\pm 0.5$  (  $\pm 0.02$  )
  4. Case Tolerance:  $\pm 0.5$  (  $\pm 0.02$  )
  5. Stand-off tolerance:  $\pm 0.1$  (  $\pm 0.004$  )

### PIN CONNECTIONS

PIN NUMBER	SINGLE	DUAL
1	-V Input	-V Input
2	+V Input	+V Input
3	N.P.	N.C.
5	N.P.	N.C.
6	+V Output	+V Output
7	-V Output	Common
8	N.C.	-V Output

### PIN CONNECTIONS

PIN NUMBER	SINGLE + C	DUAL + C
1	-V Input	-V Input
2	+V Input	+V Input
3	Remote On/Off	Remote On/Off
5	N.C.	N.C.
6	+V Output	+V Output
7	-V Output	Common
8	N.C.	-V Output