

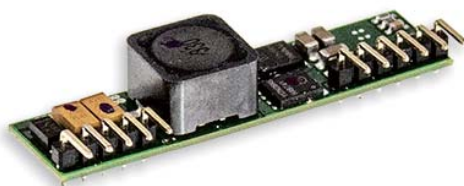

# 35W DC-DC Non-Isolated Regulated Converter

# NID35 series



### ■ Features :

- Economical open frame design
- Wide input range
- High efficiency up to 96%
- Remote ON / OFF control
- Compact size 2.0"x0.512"x 0.433"(SIP package)
- Protections: Short circuit / Overload / Over voltage
- -30~+85°C wide working temperature
- Cooling by free air convection
- Comply to BS EN/EN55032 ClassA without additional components
- Trimming output (optional)
- 3 years warranty

### ■ GTIN CODE

MW Search: <https://www.meanwell.com/serviceGTIN.aspx>



### SPECIFICATION

ORDER NO.	NID35-5		NID35-12		NID35-15		NID35-24				
OUTPUT	DC VOLTAGE		5V		12V		15V		24V		
	CURRENT RANGE		0 ~ 3.5A		0 ~ 2.9A		0 ~ 2.4A		0 ~ 1.5A		
	RATED POWER		17.5W		34.8W		36W		36W		
	RIPPLE & NOISE (max.) Note.2		100mVp-p		120mVp-p		150mVp-p		200mVp-p		
	LINE REGULATION Note.3		±0.5%		±0.5%		±0.5%		±0.5%		
	LOAD REGULATION Note.4		±0.5%		±0.5%		±0.5%		±0.5%		
	VOLTAGE TOLERANCE		±2.0%		±2.0%		±2.0%		±2.0%		
	SWITCHING FREQUENCY (Typ.)		200KHz								
	EXTERNAL CAPACITANCE LOAD (max.)		100uF / 16V low ESR		68uf/25V low ESR		47uf/50V low ESR		47uf/50V low ESR		
INPUT	VOLTAGE RANGE		10.5 ~ 53VDC		20 ~ 53VDC		20 ~ 53VDC		30 ~ 53VDC		
	NORMAL VOLTAGE		24VDC (or 12VDC or 48VDC)		24VDC (or 48VDC)		24VDC (or 48VDC)		48VDC		
	EFFICIENCY (Typ.)	24Vin	93% (12/24VDC)		95%		96%		-----		
		48Vin	89%		93%		94%		95%		
	DC CURRENT	Full load	1700mA/12VDC		1580mA/24VDC		1620mA/24VDC		840mA/48VDC		
No load		30mA		30mA		30mA		50mA			
PROTECTION		Fuse recommended (3A)									
PROTECTION	OVERLOAD (Typ.)		120 ~ 250% rated output power		Protection type : Hiccup mode, recovers automatically after fault condition is removed						
	OVER VOLTAGE		6.4 ~ 7.5V		15.6~ 18V		17.5~ 21V		28~ 33V		
	SHORT CIRCUIT		All output equipped with short circuit		Protection type : Shut off o/p voltage, clamp by TVS diode						
FUNCTION	REMOTE CONTROL		Power on : 1.2VDC < R.C ~ com < 12VDC or open circuit ; power off : R.C ~ com < 0.4VDC or short circuit (PIN5,6 & PIN11)								
ENVIRONMENT	SAFETY STANDARDS		EAC TP TC 004 approved								
	WORKING TEMP.		-30 ~ +85°C (Refer to "Derating Curve")								
	WORKING HUMIDITY		20% ~ 85% RH non-condensing								
	STORAGE TEMP.		-30 ~ +105°C								
	TEMP. COEFFICIENT		±0.03% / °C (0 ~ 55°C)								
	VIBRATION		10 ~ 500Hz, 2G 10min./1 cycle, period for 60min. each along X, Y, Z axes								
SAFETY & EMC	SAFETY STANDARD		BS EN/EN62368-1(LVD)								
	EMC EMISSION	Parameter		Standard		Test Level / Note					
		Conducted		BS EN/EN55032		Class A without external components, Class B with external components					
		Radiated		BS EN/EN55032		Class A without external components, Class B with external components					
	EMC IMMUNITY	BS EN/EN55035		Parameter		Standard		Test Level / Note			
		Radiated		BS EN/EN61000-4-3		Level 2, 3V/m ; criteria A					
		EFT / Burst		BS EN/EN61000-4-4		Level 2, 1KV ; criteria A					
Surge		BS EN/EN61000-4-5		Level 2, 1KV/Line-Line, criteria A							
Conducted		BS EN/EN61000-4-6		Level 2, 3V ; criteria A							
OTHERS	MTBF		12321.5K hrs min. Telcordia SR-332 (Bellcore) ; 757.9K hrs min. MIL-HDBK-217F (25°C)								
	DIMENSION		50.8*13*11mm or 2.0**0.512**0.433" inch (L*W*H)								
	WEIGHT		9g;440psc/4.96Kg/0.94CUFT								
NOTE	1.All parameters are specified at normal input, rated load, 25°C 70% RH Ambient.		2.Ripple & noise are measured at 20MHz by using a 12" twisted pair terminated with a 0.1uf & 47uf capacitor.		3.Line regulation is measured from low line to high line at rated load.		4.Load regulation is measured from 10% to 100% rated load.		※ Product Liability Disclaimer : For detailed information, please refer to <a href="https://www.meanwell.com/serviceDisclaimer.aspx">https://www.meanwell.com/serviceDisclaimer.aspx</a>		

### ■ Connection diagram to obtain negative output voltage

(Unit:mm|inch) Tolerance:±1|±0.04|  
 Note:input voltage must be < 30VDC.

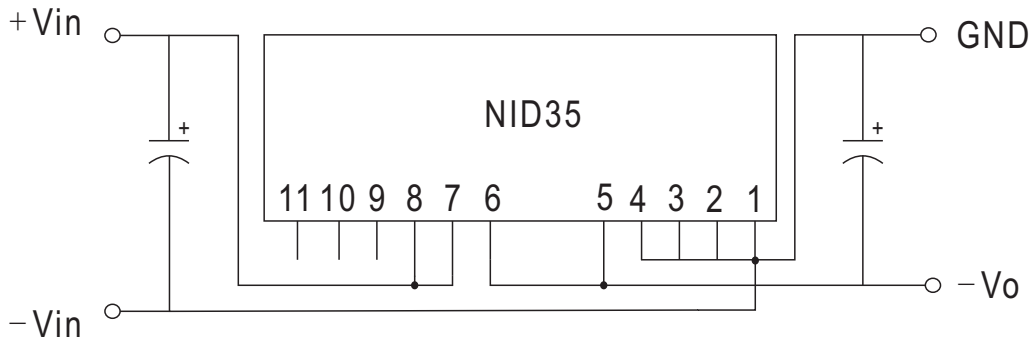

### ■ Derating Curve

#### NID-35-5

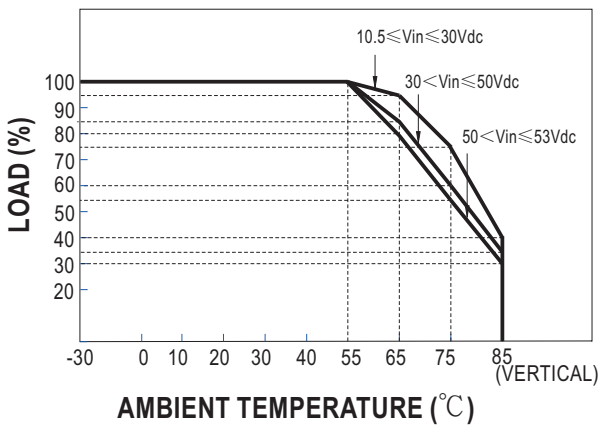

#### NID-35-12,15

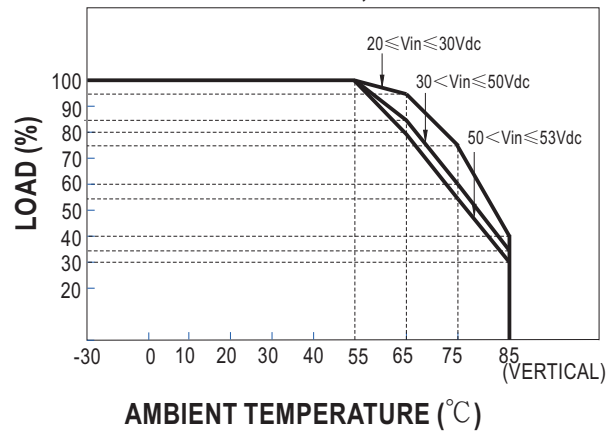

#### NID-35-24

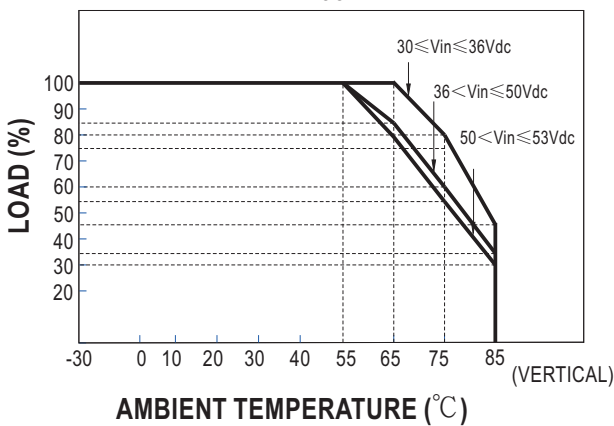

### Mechanical Specification

(Unit:mm[inch], Tolerance:±1[±0.04])

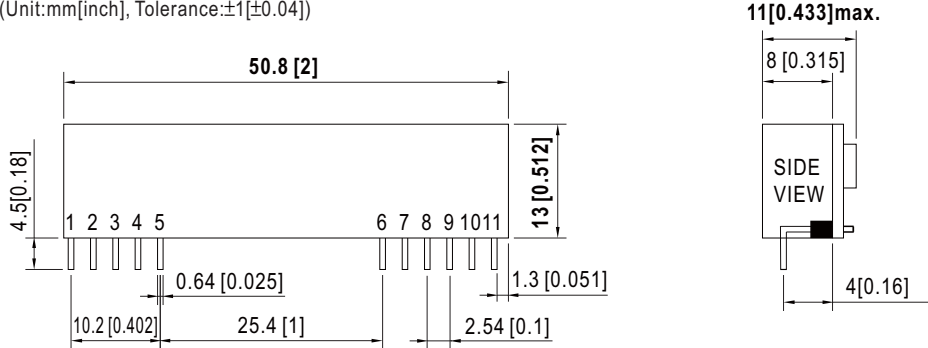

### Pin Configuration

Pin No.	Pin_Out
1,2,3,4	+Vout
5,6	Com
7,8	+Vin
9	N.C.
10	Trim(optional)
11	R.C.

### EMC Suggestion Circuit

※Comply to EN55032 Class A without additional componenets ,required external componenets to meet Class B emisson are as below:

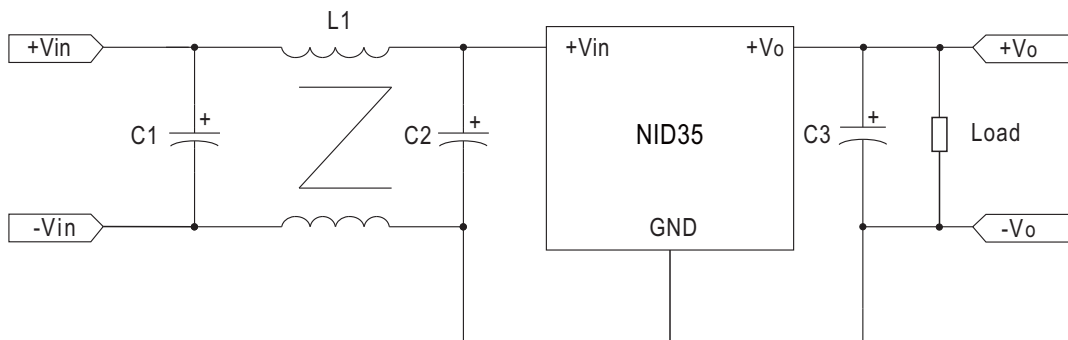

C1/C2	L1	C3
120 μ F /63V	15 μ H(NiZn)	22 μ F/35V