

M10A Series

10W 4:1 Regulated Single & Dual output

Features

- Ultra Wide 4:1 Input Range
- 1600 VDC Isolation
- Efficiency up to 87%
- Extended Operation Temperature Range -40 ~ +100°C
- No Minimum Load Required
- Continuous Short Circuit Protection
- Over Load Protection
- Under Voltage Lockout
- Adjustable Output Voltage
- High Power Density: 10W in DIL-16 Package
- Built-in EMI filter meets EN55032 Class A



The M10A series is a family of high performance 10W single & dual output DC-DC converters. These converters are built in copper package in a 16-pin DIP miniature compact case with high performance features wide range devices operate over 4:1 input voltage range providing stable output voltage which is much smaller than package of DIP-24. Devices are encapsulated using flame retardant resin. Input voltages are 24 Vdc and 48 Vdc with output voltage of 3.3, 5, 12, 15, 24, ± 12 , ± 15 Vdc. Featuring new PWM construction, no minimum load required and precise 1% output voltage accuracy.

All specifications typical at Ta=25°C, nominal input voltage and full load unless otherwise specified.

OUTPUT SPECIFICATIONS	
Voltage Accuracy	$\pm 1\%$, max.
Output Voltage Adjustability(Trim)	$\pm 10\%$, max.
Output Current	See table, max.
Line Regulation	$\pm 0.5\%$, max.
Load Regulation (From 0% to 100% Load)	Single : $\pm 1\%$, max. (Output Voltage Balance)Dual : $\pm 1\%$, max.
Cross Regulation (Dual Output) (1)	$\pm 5\%$, max.
Ripple & Noise (20MHz bandwidth)(2)	3.3V & 5V : 60mV _{pk-pk} , max. Others : 80mV _{pk-pk} , max.
Over Load Protection	160%, typ.
Short Circuit Protection	Indefinite (Automatic Recovery)
Temperature Coefficient	$\pm 0.02\%/^{\circ}\text{C}$
Capacitive Load(3)	See table, max.
Transient Recovery Time(4)	250 μs , typ.
Transient Response Deviation(4)	Output 3.3V & 5V : $\pm 5\%$, max. Others : $\pm 3\%$, max.

INPUT SPECIFICATIONS	
Voltage Range	See table
Start up Time(Nominal Vin and constant resistive load)	20ms, typ.
Input Filter	Pi Type
Input Current (No-Load)	See table, typ.
Input Current (Full-Load)	See table, typ.
Input Reflected Ripple Current(5)	20mA _{pk-pk} , max.
Under voltage lockout	
24V Module ON / OFF	8.8Vdc / 7.0Vdc, typ.
48V Module ON / OFF	17.8Vdc / 16.0Vdc, typ.

ABSOLUTE MAXIMUM RATINGS(6)	
These are stress ratings. Exposure of devices to any of these conditions may adversely affect long-term reliability.	
Input Surge Voltage (100ms max.)	
24 Models	50Vdc, max.
48 Models	100Vdc, max.
Soldering Temperature (1.5mm from case 10sec max.)	260°C, max.

GENERAL SPECIFICATIONS	
Efficiency	See table, typ.
I/O Isolation Voltage (60sec)	
Input / Output	1600Vdc
Case / Input & Output	1000Vdc
I/O Isolation Resistance	1G Ω , min.
I/O Isolation Capacity	1200pF, max.
Switching Frequency	370kHz, typ.
Humidity	5-95% rel H
Reliability Calculated MTBF (MIL-HDBK-217 F)	485khrs, min.
Safety Standard	UL/cUL 62368-1 IEC/EN 60950-1, 62368-1
Safety Approvals	UL/cUL 62368-1 IEC/EN 60950-1, 62368-1

PHYSICAL SPECIFICATIONS	
Case Material	Copper
Base Material	Non-conductive Black Plastic (UL94V-0 rated)
Potting Material	Epoxy (UL94V-0 rated)
Pin Material	$\Phi 0.5\text{mm}$ Brass Solder-coated
Weight	10g, typ.
Dimensions	0.94"x0.54"x0.41"

ENVIRONMENT SPECIFICATIONS	
Operating Temperature	-40°C ~ +100°C(See Derating Curve)
Maximum Case Temperature	105°C
Thermal Impedance	18°C/W, min.
Storage Temperature	-55°C ~ +125°C
Cooling(7)	Nature Convection

EMC CHARACTERISTICS		
Radiated Emissions	EN55032	CLASS A
Conducted Emissions	EN55032	CLASS A
ESD	IEC61000-4-2	Perf. Criteria A
RS	IEC61000-4-3	Perf. Criteria A
EFT(8)	IEC61000-4-4	Perf. Criteria A
Surge(8)	IEC61000-4-5	Perf. Criteria A
CS	IEC61000-4-6	Perf. Criteria A
PFMF	IEC61000-4-8	Perf. Criteria A

PART NUMBER STRUCTURE

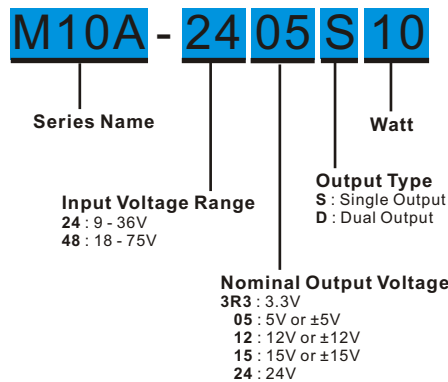

MODEL SELECTION GUIDE

MODEL NUMBER	INPUT Voltage Range (Vdc)	INPUT Current (mA)		OUTPUT Voltage (Vdc)	OUTPUT Current		Efficiency @FL (% , typ.)	Capacitor Load @FL (µF,max.)
		No-Load (mA, max.)	Full-Load (mA, typ.)		No load (mA)	Full load (mA)		
M10A-243R3S10	24 (9 - 36)	10	464	3.3	0	2700	80	3300
M10A-2405S10	24 (9 - 36)	10	502	5	0	2000	83	2200
M10A-2412S10	24 (9 - 36)	10	479	12	0	833	87	1000
M10A-2415S10	24 (9 - 36)	10	479	15	0	666	87	680
M10A-2424S10	24 (9 - 36)	10	479	24	0	416	87	330
M10A-2412D10	24 (9 - 36)	10	478	±12	0	±416	87	680#
M10A-2415D10	24 (9 - 36)	10	478	±15	0	±333	87	470#
M10A-483R3S10	48 (18 - 75)	7	232	3.3	0	2700	80	3300
M10A-4805S10	48 (18 - 75)	7	251	5	0	2000	83	2200
M10A-4812S10	48 (18 - 75)	7	239	12	0	833	87	1000
M10A-4815S10	48 (18 - 75)	7	239	15	0	666	87	680
M10A-4824S10	48 (18 - 75)	7	239	24	0	416	87	330
M10A-4812D10	48 (18 - 75)	7	239	±12	0	±416	87	680#
M10A-4815D10	48 (18 - 75)	7	239	±15	0	±333	87	470#

For each output

NOTE

1. One load is 25% to 100% load, the other load is 100% load, the output voltage variable rate is within ±5%.
2. Measured with a 1µF ceramic capacitor and a 10µF electrolytic capacitor.
3. Tested by minimal Vin and constant resistive load.
4. Tested by normal Vin and 100%~25% load, 25% load step change.
5. Measured with a simulated source inductance of 8.2µH and a source capacitor Cin(47µF, ESR<1.0Ω at 100KHz).
6. Exceeding the absolute ratings of the unit could cause damage. It's not allowed for continuous operating ratings.
7. "Nature Convection" is usually about 30~65 LFM but is not equal to still air (0 LFM).
8. An external filter is required if the module has to meet IEC61000-4-4 and IEC61000-4-5.
The filter capacitor Motien suggest: 24Vin models : Nippon - chemi - con KY series, 220µF/100V and a TVS,58V,3kW.
48Vin models : Nippon - chemi - con KY series, 220µF/100V and a TVS,120V,3kW.

POWER DERATING CURVE

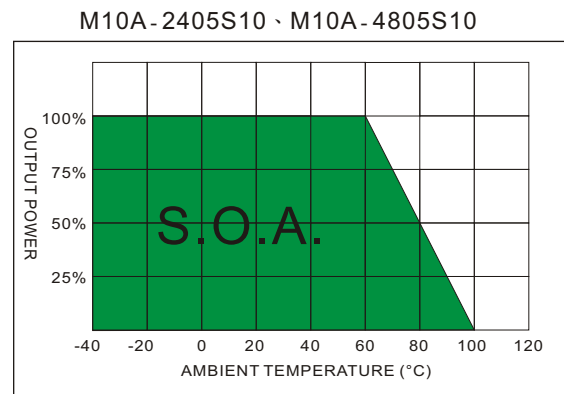
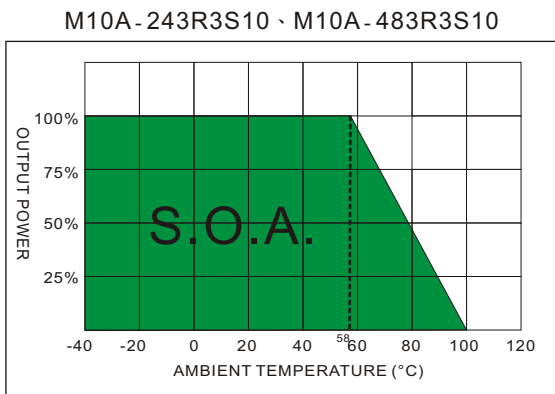

M10A-2412S10、M10A-2415S10、M10A-2424S10、M10A-2412D10、M10A-2415D10、
M10A-4812S10、M10A-4815S10、M10A-4824S10、M10A-4812D10、M10A-4815D10

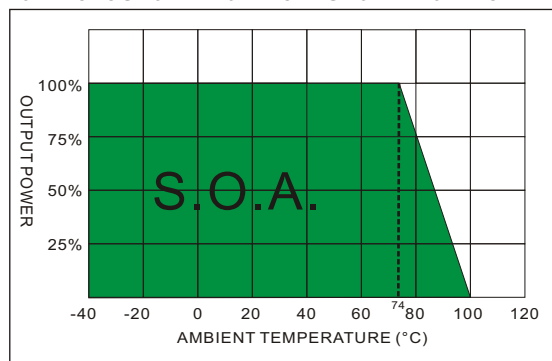

TEST CONFIGURATIONS

Output Ripple & Noise Measurement Test

To reduce ripple and noise, it's recommended to connect a 1μF ceramic disk capacitor and a 10μF electrolytic capacitor to output.

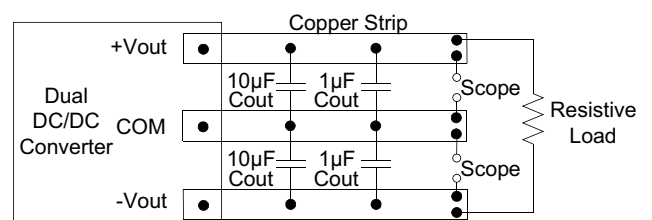
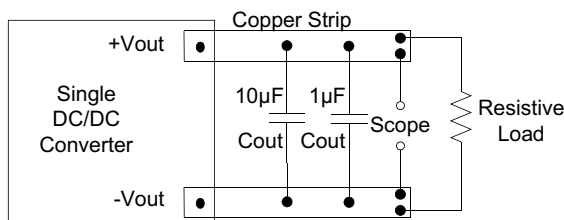

Input Reflected Ripple Current Test

Input reflected ripple current is measured with a source inductor L_{in} (8.2μH) and a source capacitor C_{in} (47μF, ESR<1.0Ω at 100KHz) at nominal input and full load.

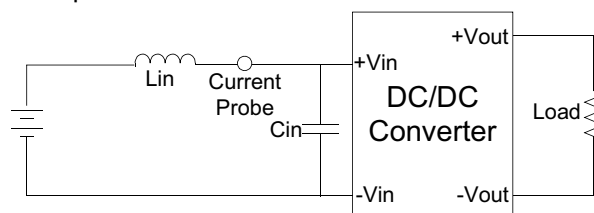

TEST CONFIGURATIONS

EFT & Surge Test

The filter capacitor Motien suggest:

24Vin models : Nippon - chemi - con KY series, 220µF/100V and a TVS,58V,3kW.

48Vin models : Nippon - chemi - con KY series, 220µF/100V and a TVS,120V,3kW.

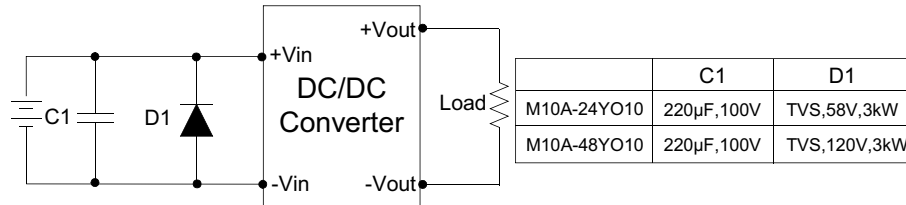

DESIGN CONFIGURATIONS

Output Voltage Adjustment (Single output models only)

Pin 7 via a resistor to Pin 9(+Vout), Vo trim down. Pin 7 via a resistor to Pin 10(-Vout), Vo trim up.

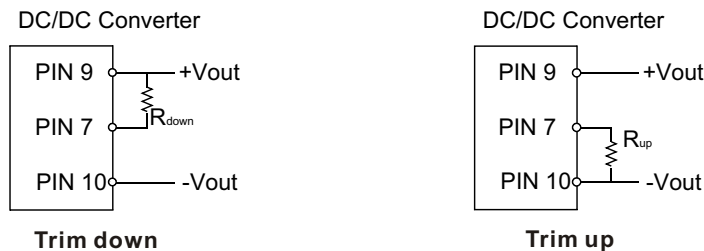

MECHANICAL SPECIFICATIONS

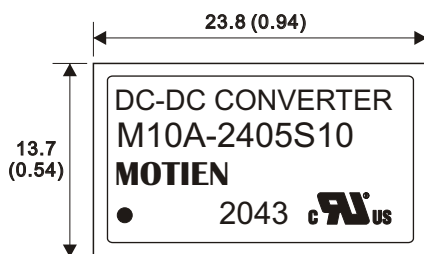

Top view

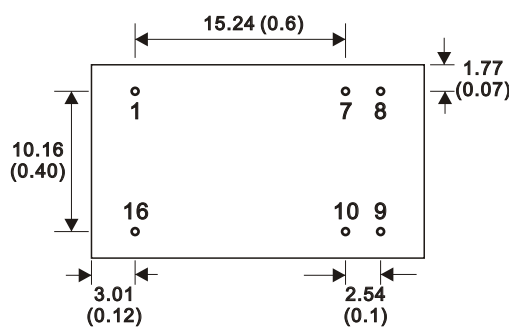

Bottom view

PIN CONNECTIONS		
PIN NUMBER	SINGLE	DUAL
1	-V Input	-V Input
7	Trim	NC
8	NC	Common
9	+V Output	+V Output
10	-V Output	-V Output
16	+V Input	+V Input

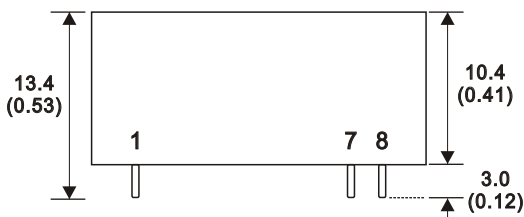

Side view (Front)

16 Pin DIL Package

- Notes : All dimensions are typical in millimeters (inches).
1. Pin diameter: 0.5±0.05 (0.02±0.002)
 2. Pin pitch and length tolerance: ±0.35 (±0.014)
 3. Pin to case tolerance: ±0.5 (±0.02)
 4. Case Tolerance: ±0.5 (±0.02)