



CQB75W Series
Application Note V12 February 2020

ISOLATED DC-DC CONVERTER
CQB75W SERIES
APPLICATION NOTE



Approved By:

Department	Approved By	Checked By	Written By
Research and Development Department	Enoch	Danny	Joyce
		Jacky	
Quality Assurance Department	Ryan	Benny	



CQB75W Series

Application Note V12 February 2020

Contents

1. Introduction	3
2. DC-DC Converter Features.....	3
3. Electrical Block Diagram	3
4. Technical Specifications.....	4
5. Main Features and Functions.....	8
5.1 Operating Temperature Range.....	8
5.2 Output Voltage Adjustment.....	8
5.3 Over Current Protection.....	8
5.4 Output Overvoltage Protection.....	8
5.6 Remote On/Off.....	8
5.7 UVLO (Under Voltage Lock Out)	8
5.8 Over Temperature Protection	8
6. Applications.....	8
6.1 Recommended Layout, PCB Footprint and Soldering Information	8
6.2 Convection Requirements for Cooling	9
6.3 Thermal Considerations.....	9
6.4 Power Derating.....	10
6.5 Quarter Brick Heat Sinks:	12
6.6 Efficiency VS. Load:	13
6.7 Test Set-Up.....	15
6.8 Output Voltage Adjustment.....	15
6.10 Output Ripple and Noise.....	16
6.11 Output Capacitance.....	16
7. Safety & EMC.....	17
7.1 Input Fusing and Safety Considerations.....	17
7.2 EMC Considerations.....	17
8. Part Number	21
9. Mechanical Specifications	21
9.1 Mechanical Outline Diagrams.....	21



CQB75W Series

Application Note V12 February 2020

1. Introduction

This specification describes the features and functions of Cincon's CQB75W series of isolated DC-DC Converters. These are highly efficient, reliable and compact, high power density, single output DC/DC converters. The modules can be used in the field of telecommunications, data communications, wireless communications, servers etc. The CQB75W series can deliver up to 12A output current and provide a precisely regulated output voltage over a wide range of input voltages ($V_i = 9- 36$ or $18- 75V_{dc}$). The modules can achieve high efficiency up to 87%. The module offers direct cooling of dissipative components for excellent thermal performance. Standard features include remote On/Off, remote sense, output voltage adjustment, over voltage, over current and over temperature protection. The CQB75W series also have the following options: remote On/Off (positive or negative).

2. DC-DC Converter Features

- 39.6-75W Isolated Output
- Efficiency to 87%
- Fixed Switching Frequency
- Regulated Output
- Continuous Short Circuit Protection
- Industry Standard Quarter-Brick Package
- UL60950-1 2nd Approval

3. Electrical Block Diagram

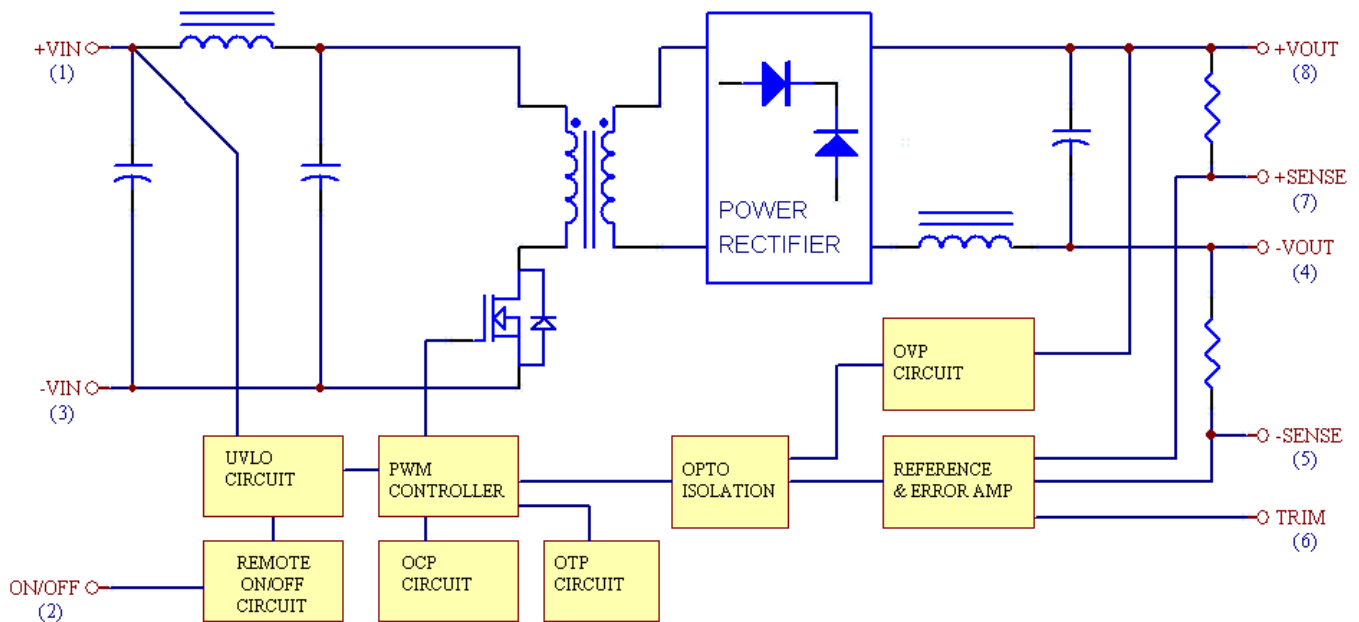

Electrical Block Diagram for other modules



CQB75W Series

Application Note V12 February 2020

4. Technical Specifications

(All specifications are typical at nominal input, full load at 25°C unless otherwise noted.)

ABSOLUTE MAXIMUM RATINGS

PARAMETER	NOTES and CONDITIONS	Device	Min.	Typical	Max.	Units
Input Voltage						
Continuous		24SXX	-0.3		36	V _{dc}
		48SXX	-0.3		75	
Transient	100ms	24SXX			50	V _{dc}
		48SXX			100	
Operating Case Temperature		All	-40		100	°C
Storage Temperature		All	-55		105	°C
Isolation Voltage	1 minute; input/output, input/case, output/case	All	1500			V _{dc}

INPUT CHARACTERISTICS

PARAMETER	NOTES and CONDITIONS	Device	Min.	Typical	Max.	Units
Operating Input Voltage		24SXX	9	24	36	V _{dc}
		48SXX	18	48	75	
Input Under Voltage Lockout		All				
Turn-On Voltage Threshold		24SXX	8	8.5	8.8	V _{dc}
		48SXX	16.5	17	17.5	
Turn-Off Voltage Threshold		24SXX	7.7	8	8.3	V _{dc}
		48SXX	15.5	16	16.5	
Lockout Hysteresis Voltage		24SXX		0.5		V _{dc}
		48SXX		0.9		
Maximum Input Current	100% Load, V _{in} =9V for 24SXX 100% Load, V _{in} =18V for 48SXX	24SXX		9.7		A
		48SXX		4.7		
No-Load Input Current		24S3V3 24S05 24S12 24S15 24S24		50		mA
		48S3V3 48S05 48S12 48S15 48S24		30		
Inrush Current (I ² t)		All			0.1	A ² s
Input Reflected Ripple Current	P-P thru 12uH Inductor, 5Hz to 20MHz	All		30		mA



CQB75W Series

Application Note V12 February 2020

OUTPUT CHARACTERISTICS

PARAMETER	NOTES and CONDITIONS	Device	Min.	Typical	Max.	Units
Output Voltage Set Point	V_{in} =Nominal V_{in} , $I_o = I_{o_max}$, $T_c=25^\circ C$	$V_o=3.3 V_{dc}$ $V_o=5.0 V_{dc}$ $V_o=12 V_{dc}$ $V_o=15 V_{dc}$ $V_o=24 V_{dc}$	3.267 4.95 11.88 14.85 23.76	3.3 5 12 15 24	3.333 5.05 12.12 15.15 24.24	V_{dc}
Output Voltage Regulation						
Load Regulation	$I_o=I_{o_min}$ to I_{o_max}	All			± 0.2	%
Line Regulation	V_{in} =low line to high line	All			± 0.2	%
Temperature Coefficient	$T_c=-40^\circ C$ to $100^\circ C$	All			± 0.03	%/ $^\circ C$
Output Voltage Ripple and Noise	5Hz to 20MHz bandwidth					
Peak-to-Peak	Full load, 10uF tantalum and 1.0uF ceramic capacitors	$V_o=3.3V$ & $5.0V$ $V_o=12V$ & $15V$ $V_o=24V$			100 150 240	mV
RMS	Full load, 10uF tantalum and 1.0uF ceramic capacitors	$V_o=3.3V$ & $5.0V$ $V_o=12V$ & $15V$ $V_o=24V$			40 60 100	mV
Operating Output Current Range		$V_o=3.3 V_{dc}$ $V_o=5.0 V_{dc}$ $V_o=12 V_{dc}$ $V_o=15 V_{dc}$ $V_o=24 V_{dc}$	0 0 0 0 0		12 12 6.25 5 3.12	A
Output DC Current Limit Inception	Output Voltage=90% Nominal Output Voltage	All	110	125	150	%
Maximum Output Capacitance	Full load (resistive)	$V_o=3.3 V_{dc}$ $V_o=5.0 V_{dc}$ $V_o=12 V_{dc}$ $V_o=15 V_{dc}$ $V_o=24 V_{dc}$	0 0 0 0 0		14700 14700 7800 4400 1500	μF

DYNAMIC CHARACTERISTICS

PARAMETER	NOTES and CONDITIONS	Device	Min.	Typical	Max.	Units
Output Voltage Current Transient						
Step Change in Output Current	75% to 100% of I_{o_max}	All			± 5	%
Setting Time (within 1% V_{out} nominal)	$d_i/d_t=0.1A/us$	All			500	us
Turn-On Delay and Rise Time						
Turn-On Delay Time, From On/Off Control	$V_{on/off}$ to 10% V_{o_set}	All		10		ms
Turn-On Delay Time, From Input	V_{in_min} to 10% V_{o_set}	All		10		ms
Output Voltage Rise Time	10% V_{o_set} to 90% V_{o_set}	All		8		ms



CQB75W Series

Application Note V12 February 2020

EFFICIENCY

PARAMETER	NOTES and CONDITIONS	Device	Min.	Typical	Max.	Units
100% Load		24S3V3		81		%
		24S05		84		
		24S12		86		
		24S15		86		
		24S24		86		
		48S3V3		82		
		48S05		85		
		48S12		86		
		48S15		87		
		48S24		87		

ISOLATION CHARACTERISTICS

PARAMETER	NOTES and CONDITIONS	Device	Min.	Typical	Max.	Units
Isolation Voltage	1 minute; input/output, input/case, output/case	All			1500	V _{dc}
Isolation Resistance		All	10			MΩ
Isolation Capacitance		All		1000		pF

FEATURE CHARACTERISTICS

PARAMETER	NOTES and CONDITIONS	Device	Min.	Typical	Max.	Units
Switching Frequency		All		300		KHz
On/Off Control, Positive Remote On/Off logic						
Logic Low (Module Off)	V _{on/off}	All	0		1.8	V
Logic High (Module On)	V _{on/off}	All	3.5 or Open Circuit		75	V
On/Off Control, Negative Remote On/Off logic						
Logic High (Module Off)	V _{on/off}	All	3.5 or Open Circuit		75	V
Logic Low (Module On)	V _{on/off}	All	0		1.8	V
On/Off Current (for both remote on/off logic)	I _{on/off} at V _{on/off} =0.0V	All		0.3	1	mA
Leakage Current (for both remote on/off logic)	Logic High, V _{on/off} =15V	All			30	uA
Off Converter Input Current	Shutdown input idle current	All		4	10	mA
Output Voltage Trim Range	P _{out} =max rated power	All	-10		+10	%
Output Over Voltage Protection		All	115	125	140	%
Over-Temperature Shutdown		All		105		°C



CQB75W Series Application Note V12 February 2020

GENERAL SPECIFICATIONS

PARAMETER	NOTES and CONDITIONS	Device	Min.	Typical	Max.	Units
MTBF	$I_o=100\%$ of I_{o_max} ; $T_a=25^\circ\text{C}$ per MIL-HDBK-217F	All		850		K hours
Weight		All		63		grams



CQB75W Series

Application Note V12 February 2020

5. Main Features and Functions

5.1 Operating Temperature Range

The CQB75W series converters can be operated within a wide case temperature range of -40°C to 100°C . Consideration must be given to the derating curves when ascertaining maximum power that can be drawn from the converter. The maximum power drawn from quarter brick models is influenced by usual factors, such as:

- Input voltage range
- Output load current
- Forced air or natural convection

5.2 Output Voltage Adjustment

Section 6.8 describes in detail how to trim the output voltage with respect to its set point. The output voltage on all models is adjustable within the range of $+10\%$ to -10% .

5.3 Over Current Protection

The converter is protected against over current or short circuit conditions. At the instance of current-limit inception, the module enters a hiccup mode of operation, whereby it shuts down and automatically attempts to restart. While the fault condition exists, the module will remain in this hiccup mode, and can remain in this mode until the fault is cleared. The unit operates normally once the output current is reduced back into its specified range.

5.4 Output Overvoltage Protection

The output overvoltage protection consists of circuitry that internally limits the output voltage. If more accurate output over voltage protection is required then an external circuit can be used via the remote on/off pin.

5.6 Remote On/Off

The CQB75W series allows the user to switch the module on and off electronically with the remote on/off feature. All models are available in "positive logic" and "negative logic" (optional) versions. The converter turns on if the remote on/off pin is high ($>3.5\text{Vdc}$ or open circuit). Setting the pin low (0 to $<1.8\text{Vdc}$) will turn the converter off. The signal level of the remote on/off input is defined with respect to ground. If not using the remote on/off pin, leave the pin open (converter will be on). Models with part number suffix "N" are the "negative logic" remote on/off version. The unit turns off if the remote on/off pin is high ($>3.5\text{Vdc}$ or open circuit). The converter turns on if the on/off pin input is low (0 to $<1.8\text{Vdc}$). Note that the converter is off by default.

5.7 UVLO (Under Voltage Lock Out)

Input under voltage lockout is standard on the CQB75W unit. The unit will shut down when the input voltage drops below a threshold, and the unit will operate when the input voltage goes above the upper threshold.

5.8 Over Temperature Protection

These modules have an over temperature protection circuit to safeguard against thermal damage. Shutdown occurs with the maximum case reference temperature is exceeded. The module will restart when the case temperature falls below over temperature shutdown threshold.

6. Applications

6.1 Recommended Layout, PCB Footprint and Soldering Information

The system designer or end user must ensure that metal and other components in the vicinity of the converter meet the spacing requirements for which the system is approved. Low resistance and inductance PCB layout traces are the norm and should be used where possible. Due consideration must also be given to proper low impedance tracks between power module, input and output grounds. The recommended soldering profile and PCB layout are shown below.

Lead Free Wave Soldering Profile

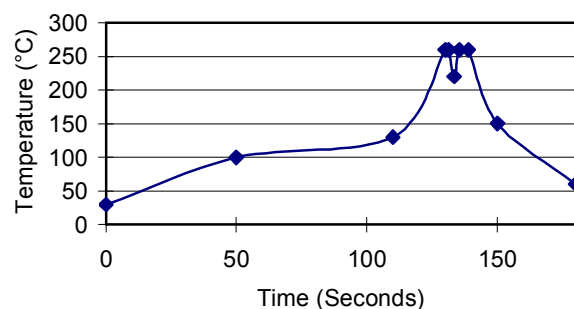

Note :

1. Soldering Materials: Sn/Cu/Ni
2. Ramp up Rate During Preheat: $1.4^{\circ}\text{C}/\text{Sec}$ (From 50°C to 100°C)
3. Soaking Temperature: $0.5^{\circ}\text{C}/\text{Sec}$ (From 100°C to 130°C), 60 ± 20 Seconds
4. Peak Temperature: 260°C , above 250°C 3~6 Seconds
5. Ramp up Rate During Cooling: $-10.0^{\circ}\text{C}/\text{Sec}$ (From 260°C to 150°C)



CQB75W Series

Application Note V12 February 2020

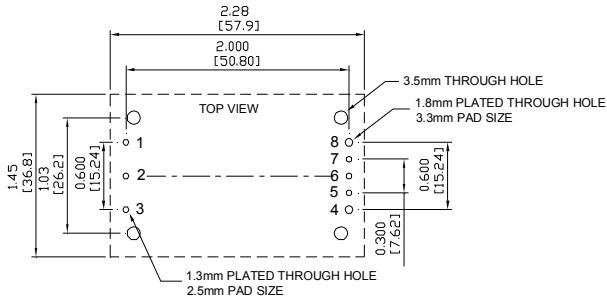

6.2 Convection Requirements for Cooling

To predict the approximate cooling needed for the Quarter brick module, refer to the power derating curves in section 6.4. These derating curves are approximations of the ambient temperatures and airflows required to keep the power module temperature below its maximum rating. Once the module is assembled in the actual system, the

module's temperature should be monitored to ensure it does not exceed 100°C as measured at the center of the top of the case (thus verifying proper cooling).

6.3 Thermal Considerations

The power module operates in a variety of thermal environments; however, sufficient cooling should be provided to help ensure reliable operation of the unit. Heat is removed by conduction, convection, and radiation to the surrounding environment. The power output of the module should not be allowed to exceed rated power ($V_{o_set} \times I_{o_max}$).

The power modules have through-threaded, M3 x0.5 mounting holes, which enable heat sinks or cold plates to be attached to the module. Thermal de-rating with heat sinks is expressed by using the overall thermal resistance of the module (R_{ca}).



CQB75W Series

Application Note V12 February 2020

6.4 Power Derating

The operating case temperature range of CQB75W series is -40°C to $+100^{\circ}\text{C}$. When operating the CQB75W series, proper de-rating or cooling is needed. The maximum case temperature under any operating condition should not exceed 100°C .

Forced Convection Power De-rating without Heat Sink

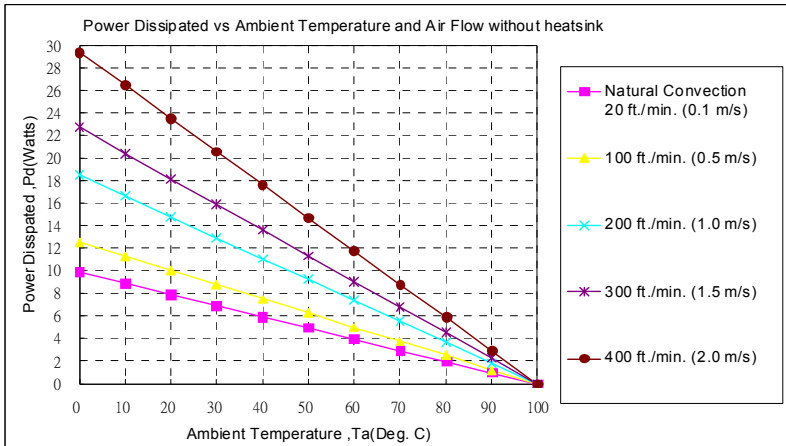

AIR FLOW RATE	TYPICAL R_{ca}
Natural Convection 20ft./min. (0.1m/s)	10.1 $^{\circ}\text{C}/\text{W}$
100 ft./min. (0.5m/s)	8.0 $^{\circ}\text{C}/\text{W}$
200 ft./min. (1.0m/s)	5.4 $^{\circ}\text{C}/\text{W}$
300 ft./min. (1.5m/s)	4.4 $^{\circ}\text{C}/\text{W}$
400 ft./min. (2.0m/s)	3.4 $^{\circ}\text{C}/\text{W}$

Example (without heatsink):

What is the minimum airflow necessary for a CQB75W-48S05 operating at nominal line voltage, an output current of 12A, and a maximum ambient temperature of 40°C ?

Solution:

Given: $V_{in}=48V_{dc}$, $V_o=5V_{dc}$, $I_o=12A$

Determine Power dissipation (P_d):

$$P_d = P_i - P_o = P_o(1 - \eta) / \eta$$

$$P_d = 5.0 \times 12 \times (1 - 0.85) / 0.85 = 10.59 \text{ Watts}$$

Determine airflow:

$$\text{Given: } P_d = 10.59 \text{ W and } T_a = 40^{\circ}\text{C}$$

Check above Power de-rating curve:

$$\text{Airflow} \leq 200 \text{ ft./min.}$$

Verifying: The maximum temperature rise $\Delta T = P_d \times R_{ca} = 10.59 \times 5.4 = 57.2^{\circ}\text{C}$

$$\text{The maximum case temperature } T_c = T_a + \Delta T = 97.2^{\circ}\text{C} < 100^{\circ}\text{C}$$

Where: The R_{ca} is thermal resistance from case to ambience.

The T_a is ambient temperature and the T_c is case temperature



CQB75W Series

Application Note V12 February 2020

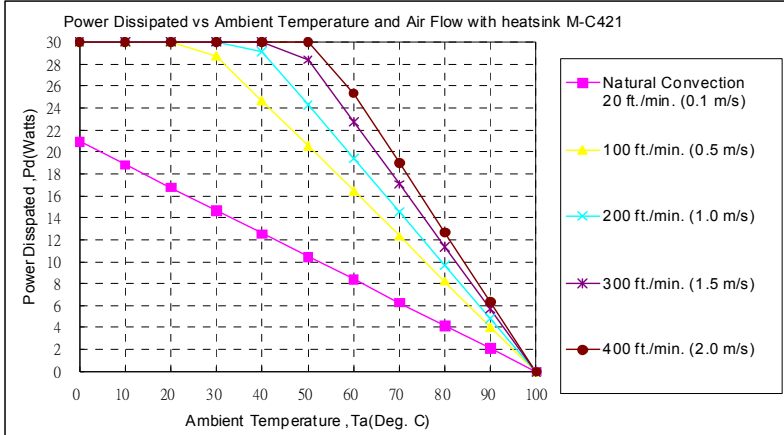

AIR FLOW RATE	TYPICAL R_{ca}
Natural Convection 20ft./min. (0.1m/s)	4.78 °C/W
100 ft./min. (0.5m/s)	2.44 °C/W
200 ft./min. (1.0m/s)	2.06 °C/W
300 ft./min. (1.5m/s)	1.76 °C/W
400 ft./min. (2.0m/s)	1.58 °C/W

Example with heatsink QBT210 (M-C421):

What is the minimum airflow necessary for a CQB75W-24S12 operating at nominal line voltage, an output current of 6.25A, and a maximum ambient temperature of 40°C?

Solution:

Given: $V_{in}=48V_{dc}$, $V_o=12V_{dc}$, $I_o=6.25A$

Determine Power dissipation (P_d):

$$P_d = P_i - P_o = P_o(1-\eta)/\eta$$

$$P_d = 12 \times 6.25 \times (1-0.86)/0.86 = 12.21 \text{ Watts}$$

Determine airflow:

$$\text{Given: } P_d = 12.21 \text{ W and } T_a = 40^\circ\text{C}$$

Check above Power de-rating curve:

$$P_d < 12.55 \text{ W, Natural Convection}$$

Verify: The maximum temperature rise $\Delta T = P_d \times R_{ca} = 12.21 \times 4.78 = 58.4^\circ\text{C}$

$$\text{The maximum case temperature } T_c = T_a + \Delta T = 98.4^\circ\text{C} < 100^\circ\text{C}$$

Where: The R_{ca} is thermal resistance from case to ambience.

The T_a is ambient temperature and the T_c is case temperature.



CQB75W Series

Application Note V12 February 2020

6.5 Quarter Brick Heat Sinks:

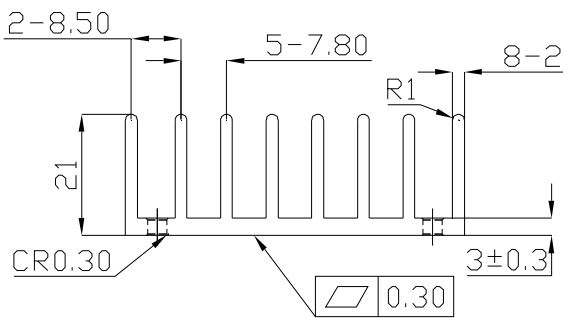
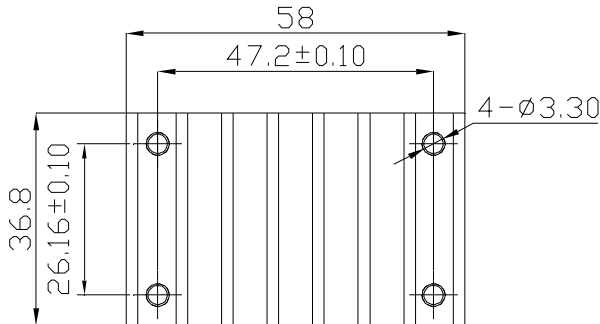

QBT210 (M-C421) G6620510201
Transverse Heat Sink

All Dimensions in mm

- Rca: 4.78°C/W (typ.), At natural convection
- 2.44°C/W (typ.), At 100LFM
- 2.06°C/W (typ.), At 200LFM
- 1.76°C/W (typ.), At 300LFM
- 1.58°C/W (typ.), At 400LFM

THERMAL PAD PQ01: SZ 35.8*56.9*0.25 mm (G6135041041)

SCREW & Washer K308W: M3*8L & WS3.2N (G75A1300322)

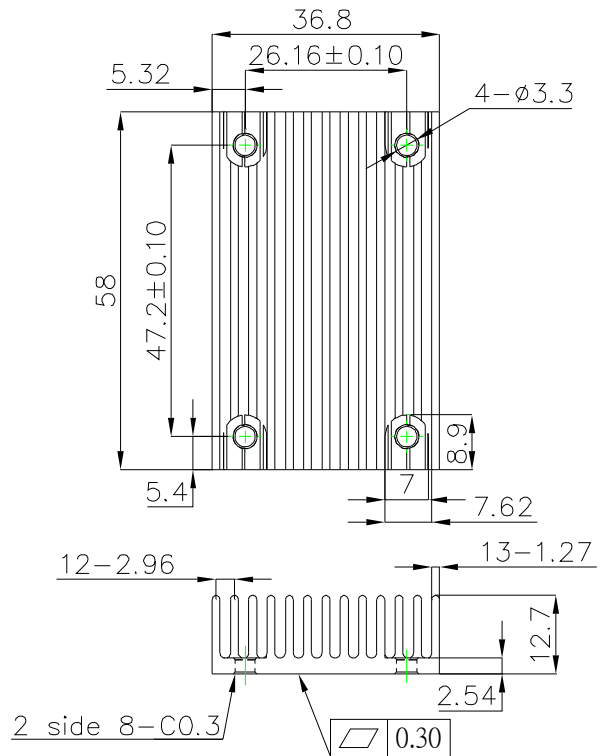

QBL127 (M-C448) G6620570202
Longitudinal Heat Sink

- Rca: 5.61°C/W (typ.), At natural convection
- 4.01°C/W (typ.), At 100LFM
- 3.39°C/W (typ.), At 200LFM
- 2.86°C/W (typ.), At 300LFM
- 2.49°C/W (typ.), At 400LFM



CQB75W Series

Application Note V12 February 2020

6.6 Efficiency VS. Load:

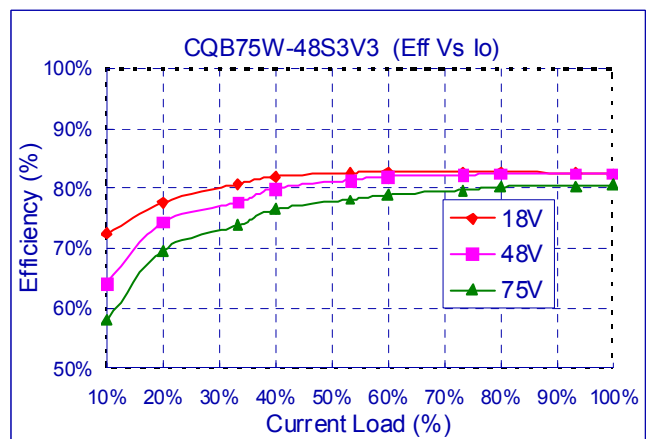
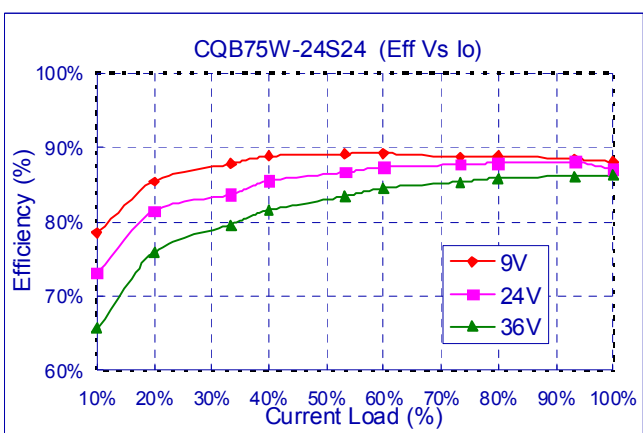
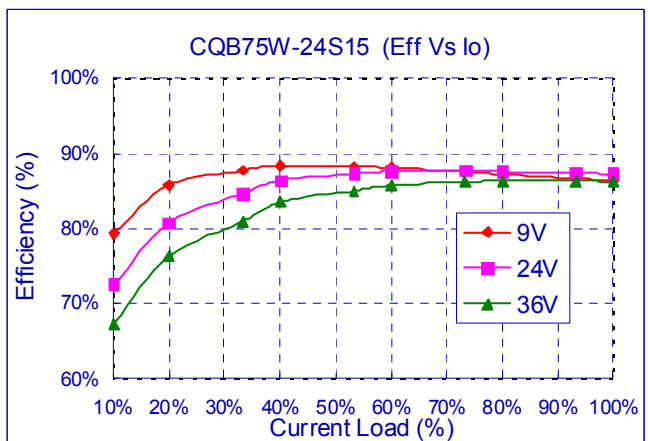
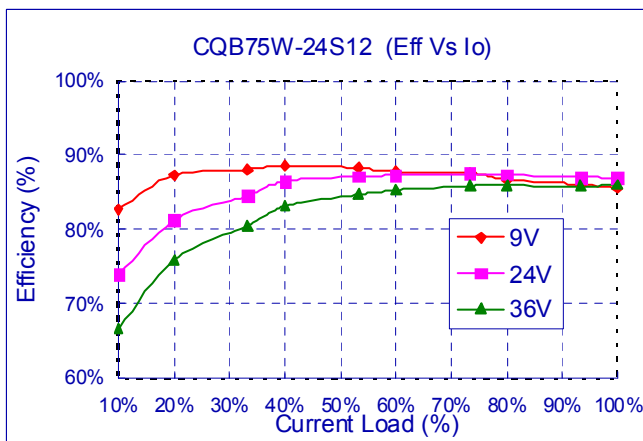
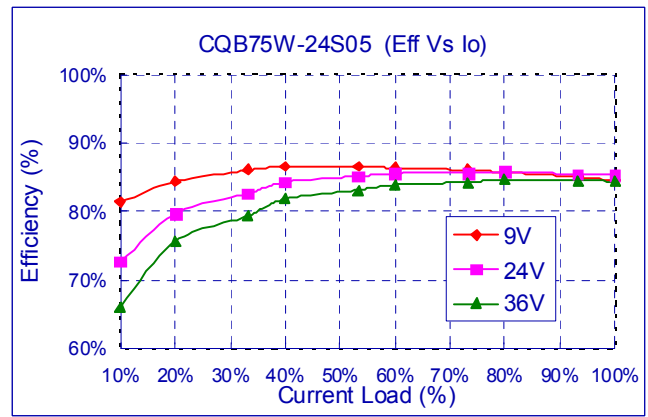
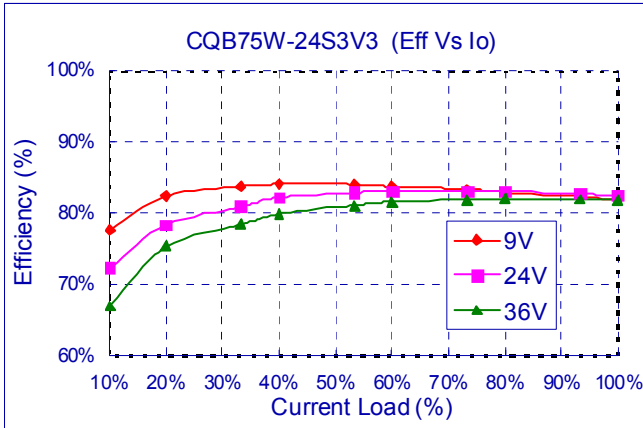



CQB75W Series

Application Note V12 February 2020

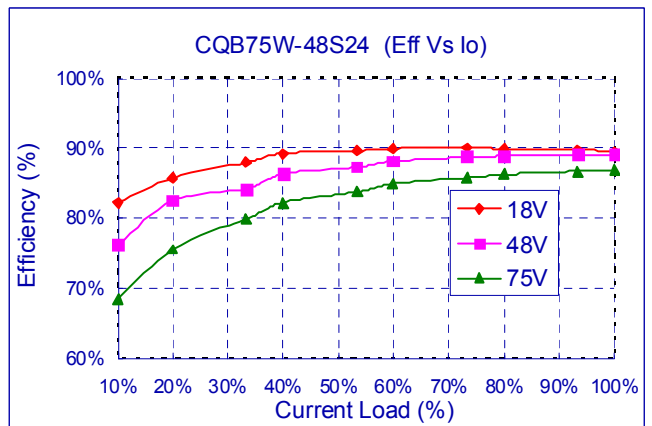
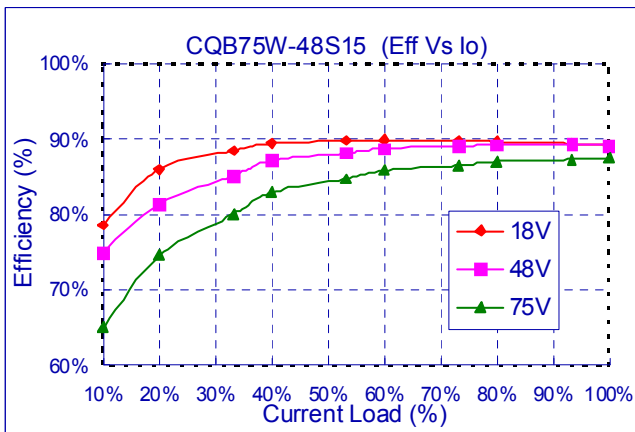
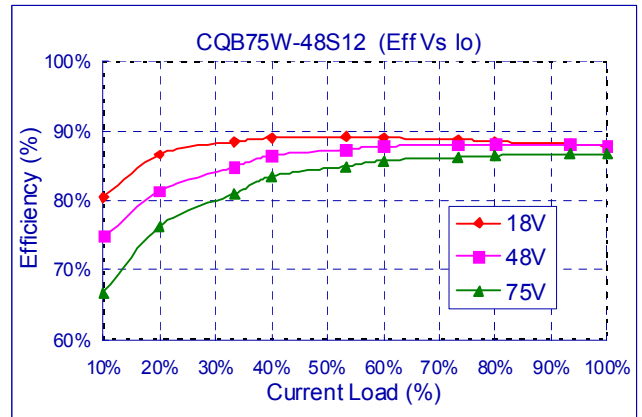
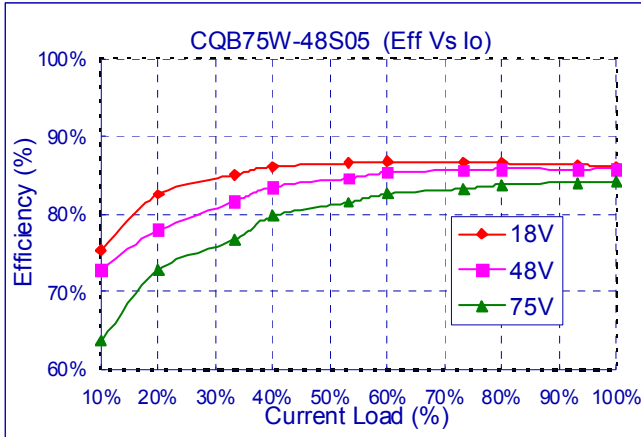



CQB75W Series

Application Note V12 February 2020

6.7 Test Set-Up

The basic test set-up to measure parameters such as efficiency and load regulation is shown below. When testing the modules under any transient conditions please ensure that the transient response of the source is sufficient to power the equipment under test. We can calculate:

- Efficiency
- Load regulation and line regulation.

The value of efficiency is defined as:

$$\eta = \frac{V_o \times I_o}{V_{in} \times I_{in}} \times 100\%$$

Where:

- V_o is output voltage,
- I_o is output current,
- V_{in} is input voltage,
- I_{in} is input current.

The value of load regulation is defined as:

$$Load\ reg = \frac{V_{FL} - V_{NL}}{V_{NL}} \times 100\%$$

Where:

- V_{FL} is the output voltage at full load
- V_{NL} is the output voltage at no load

The value of line regulation is defined as:

$$Line\ reg = \frac{V_{HL} - V_{LL}}{V_{LL}} \times 100\%$$

Where: V_{HL} is the output voltage of maximum input voltage at full load. V_{LL} is the output voltage of minimum input voltage at full load.

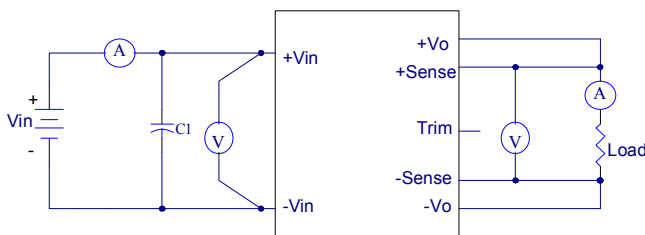

CQB100W Series Test Setup

6.8 Output Voltage Adjustment

In order to trim the voltage up or down one needs to connect the trim resistor either between the trim pin and -Vo for trim-up and between trim pin and +Vo for trim-down. The output voltage trim range is $\pm 10\%$. This is shown in Figures 1 and 2:

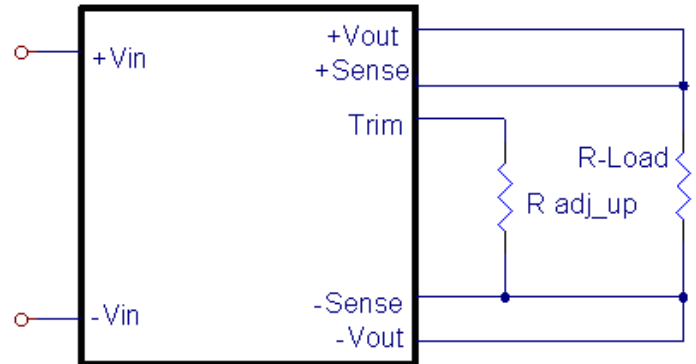

Figure 1. Trim-up Voltage Setup

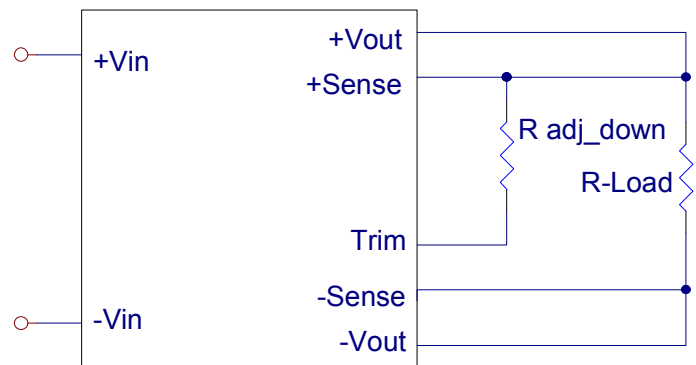

Figure 2. Trim-down Voltage Setup

1. The value of R_{trim_up} defined as:

$$R_{trim_up} = \left(\frac{R_1(V_r - V_f \left(\frac{R_2}{R_2 + R_3} \right))}{V_o - V_{o_nom}} \right) - \frac{R_2 R_3}{R_2 + R_3} \quad (\text{K}\Omega)$$

Where: R_{trim_up} is the external resistor in $\text{K}\Omega$.

V_{o_nom} is the nominal output voltage.

V_o is the desired output voltage.

R_1 , R_2 , R_3 and V_r are internal to the unit and are defined in Table 1.

Output Voltage(V)	R1 (K Ω)	R2 (K Ω)	R3 (K Ω)	Vr (V)	Vf (V)
3.3V	3.0	12	4.3	1.24	0.46
5V	2.32	3.3	0	2.5	0
12V	9.1	51	5.1	2.5	0.46
15V	12	56	8.25	2.5	0.46
24V	20	100	7.5	2.5	0.46

Table 1 – Trim Resistor Values

For example, to trim-up the output voltage of 12V module

(CQB75W-48S12) by 5% to 12.6V, R_{trim_up} is calculated as follows:

$$V_o - V_{o_nom} = 12.6 - 12 = 0.6V$$

$$R_1 = 9.1\text{K}\Omega, \quad R_2 = 51\text{K}\Omega, \quad R_3 = 5.1\text{K}\Omega, \quad V_r = 2.5V, \quad V_f = 0.46$$

$$R_{trim_up} = \frac{18.944}{0.6} - 4.636 = 26.94 \quad (\text{K}\Omega)$$



CQB75W Series

Application Note V12 February 2020

2. The value of R trim_down defined as:

$$R_{trim_down} = \frac{R_1 \times (V_o - V_r)}{V_{o_nom} - V_o} - R_2 \text{ (K}\Omega\text{)}$$

Where: R trim_down is the external resistor in Kohm.

Vo_nom is the nominal output voltage.

Vo is the desired output voltage.

R1, R2, R3 and Vr are internal to the unit and are defined in Table 1.

For example, to trim-down the output voltage of 12V module (CQB75W-48S12) by 5% to 11.4V, R trim-down is calculated as follows:

$$V_{o_nom} - V_o = 12 - 11.4 = 0.6V$$

$$R_1 = 9.1K\Omega, R_2 = 51K\Omega, V_r = 2.5V$$

$$R_{trim_down} = \frac{9.1 \times (11.4 - 2.5)}{0.6} - 51 = 83.98 \text{ (K}\Omega\text{)}$$

6.9 Output Remote Sensing

The CQB75W series converter has the capability to remotely sense both lines of its output. This feature moves the effective output voltage regulation point from the output of the unit to the point of connection of the remote sense pins. This feature automatically adjusts the real output voltage of the CQB75W series in order to compensate for voltage drops in distribution and maintain a regulated voltage at the point of load. The remote-sense voltage range is:

$$[(+V_{out}) - (-V_{out})] - [(+Sense) - (-Sense)] \leq 10\% \text{ of } V_{o_nominal}$$

If the remote sense feature is not to be used, the sense pins should be connected locally. The +Sense pin should be connected to the +Vout pin at the module and the -Sense pin should be connected to the -Vout pin at the module.

This is shown in the schematic below.

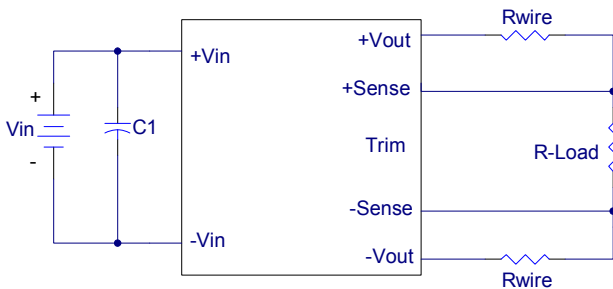

Note: Although the output voltage can be varied (increased or decreased) by both remote sense and trim, the maximum variation for the output voltage is the larger of the two values not the sum of the values. The output power delivered by the module is defined as the voltage at the output terminals multiplied by the output current. Using remote sense and trim can cause the output voltage to increase and

consequently increase the power output of the module if output current remains unchanged. Always ensure that the output power of the module remains at or below the maximum rated power. Also be aware that if $V_{o.set}$ is below nominal value, $P_{out.max}$ will also decrease accordingly because $I_{o.max}$ is an absolute limit. Thus, $P_{out.max} = V_{o.set} \times I_{o.max}$ is also an absolute limit.

6.10 Output Ripple and Noise

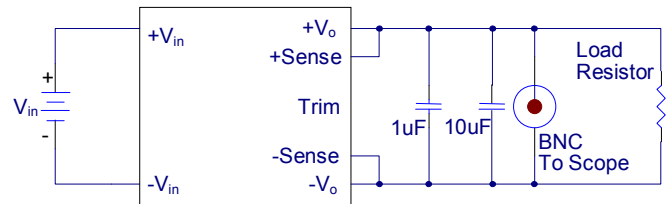

Output ripple and noise is measured with 1.0uF ceramic and 10uF solid tantalum capacitors across the output.

6.11 Output Capacitance

The CQB75W series converters provide unconditional stability with or without external capacitors. For good transient response, low ESR output capacitors should be located close to the point of load. PCB design emphasizes low resistance and inductance tracks in consideration of high current applications. Output capacitors with their associated ESR values have an impact on loop stability and bandwidth. These series converters are designed to work with load capacitance to see technical specifications



CQB75W Series Application Note V12 February 2020

7. Safety & EMC

7.1 Input Fusing and Safety Considerations

The CQB75W series converters have no internal fuse. In order to achieve maximum safety and system protection, always use an input line fuse. We recommended a 15A time delay fuse for the 24Vin models and a 8A time delay fuse for the 48Vin models. It is recommended that the circuit have a transient voltage suppressor diode (TVS) across the input terminal to protect the unit against surge or spike voltage and input reverse voltage (as shown).

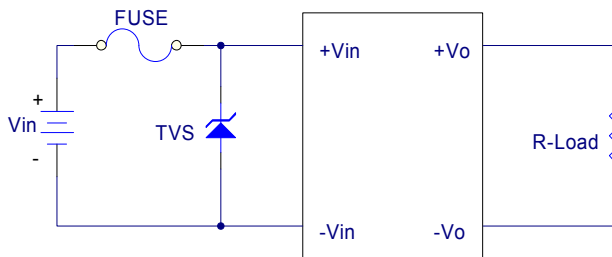

7.2 EMC Considerations

EMI Test standard: EN55022 Class A and Class B Conducted Emission
Test Condition: Input Voltage: Nominal, Output Load: Full Load

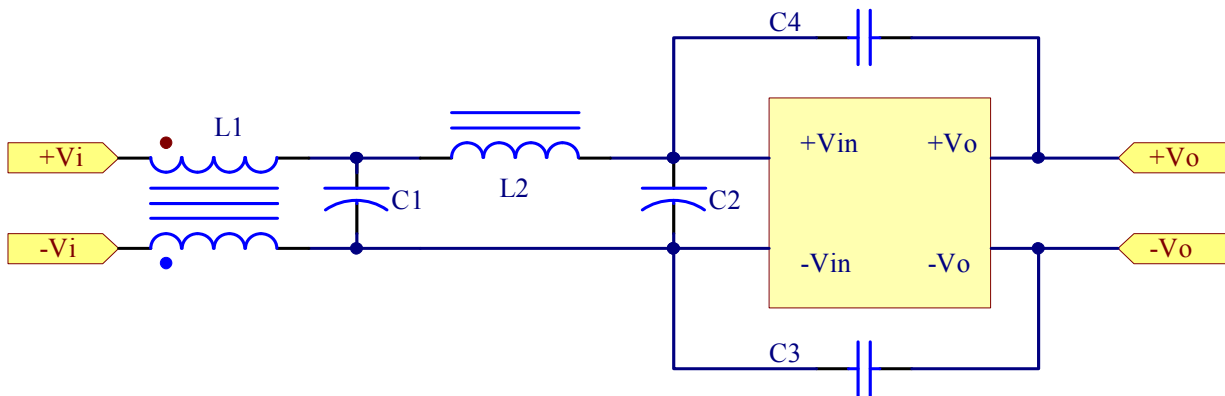

Figure1 Connection circuit for conducted EMI testing

Model No.	EN55022 class A						EN55022 class B					
	C1	C2	C3	C4	L1	L2	C1	C2	C3	C4	L1	L2
CQB75W-24S33	47uF/50V	47uF/50V	NC	1000pF	SHORT	8uH	100uF/50V	100uF/50V	1000pF	1000pF	0.2mH	8uH
CQB75W-24S05	47uF/50V	47uF/50V	NC	1000pF	SHORT	8uH	100uF/50V	100uF/50V	1000pF	1000pF	0.2mH	8uH
CQB75W-24S12	47uF/50V	47uF/50V	NC	1000pF	SHORT	8uH	100uF/50V	100uF/50V	2200pF	2200pF	0.2mH	8uH
CQB75W-24S15	47uF/50V	47uF/50V	NC	1000pF	SHORT	8uH	100uF/50V	100uF/50V	1000pF	1000pF	0.2mH	8uH
CQB75W-24S24	47uF/50V	47uF/50V	NC	1000pF	SHORT	8uH	100uF/50V	100uF/50V	1000pF	1000pF	0.2mH	8uH
CQB75W-48S33	47uF/100V	47uF/100V	NC	NC	SHORT	8uH	47uF/100V	47uF/100V	1000pF	NC	0.2mH	8uH
CQB75W-48S05	47uF/100V	47uF/100V	NC	NC	SHORT	8uH	47uF/100V	47uF/100V	1000pF	NC	0.2mH	8uH
CQB75W-48S12	47uF/100V	47uF/100V	1000pF	NC	SHORT	8uH	47uF/100V	47uF/100V	1000pF	NC	0.2mH	8uH
CQB75W-48S15	47uF/100V	47uF/100V	1000pF	NC	SHORT	8uH	47uF/100V	47uF/100V	1000pF	1000pF	0.2mH	8uH
CQB75W-48S24	47uF/100V	47uF/100V	NC	NC	SHORT	8uH	47uF/100V	47uF/100V	1000pF	NC	0.2mH	8uH



CQB75W Series

Application Note V12 February 2020

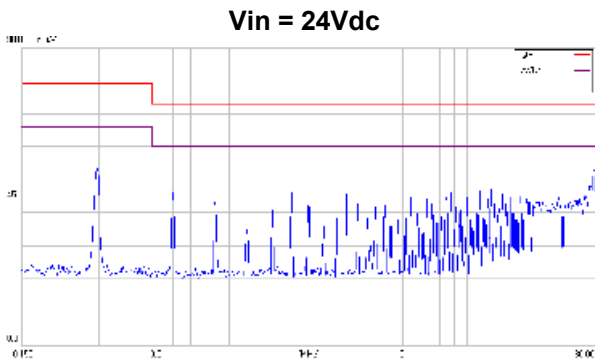

Conducted Class A of CQB75W-24S33
Vin = 24Vdc

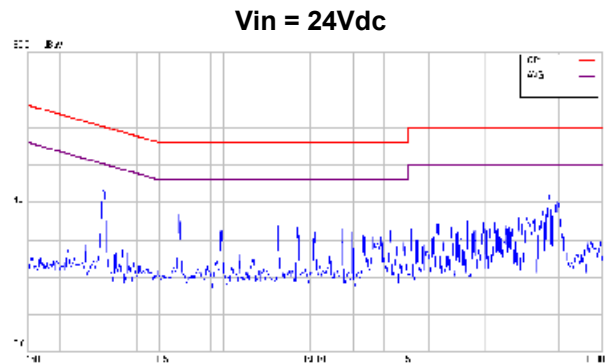

Conducted Class B of CQB75W-24S33
Vin = 24Vdc

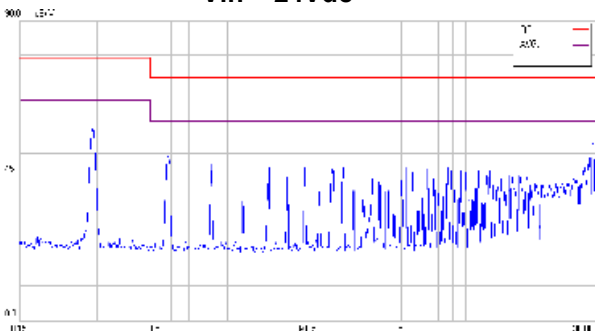

Conducted Class A of CQB75W-24S05
Vin = 24Vdc

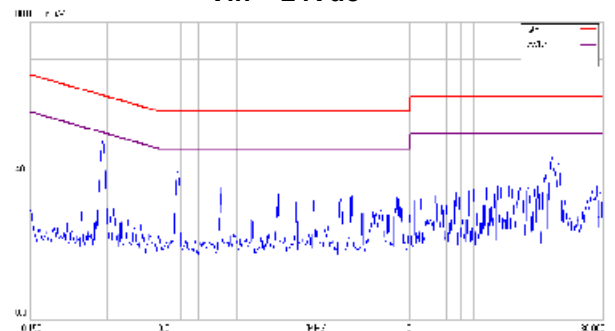

Conducted Class B of CQB75W-24S05
Vin = 24Vdc

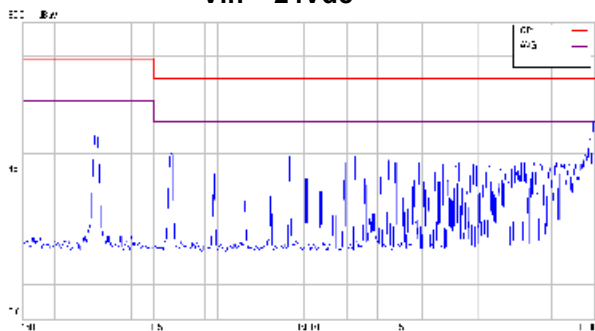

Conducted Class A of CQB75W-24S12
Vin = 24Vdc

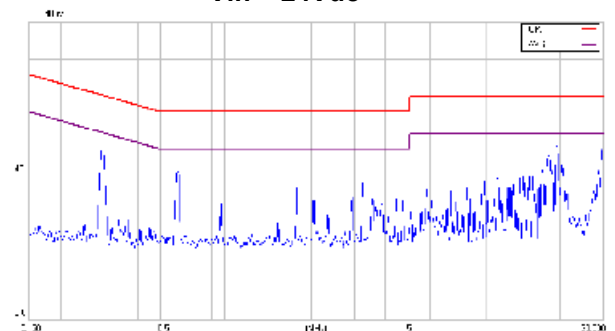

Conducted Class B of CQB75W-24S12
Vin = 24Vdc

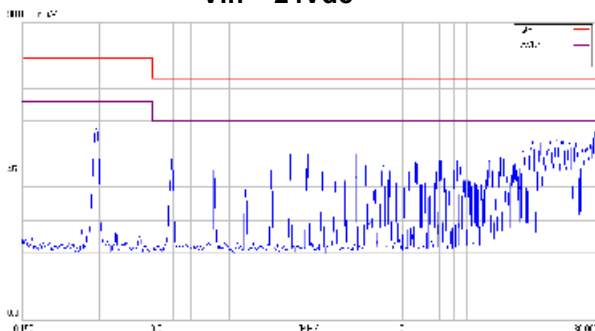

Conducted Class A of CQB75W-24S15

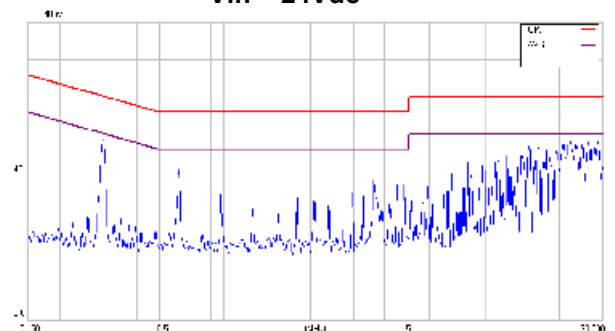

Conducted Class B of CQB75W-24S15



CQB75W Series

Application Note V12 February 2020

Vin = 24Vdc

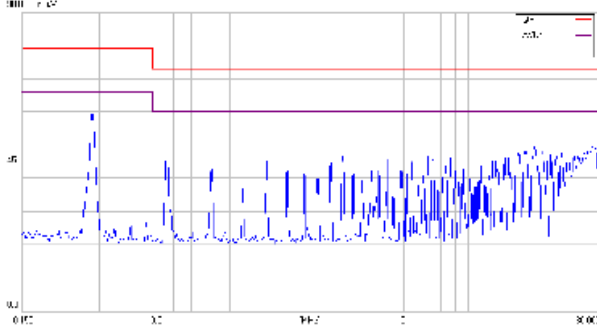

**Conducted Class A of CQB75W-24S24
Vin = 48Vdc**

Vin = 24Vdc

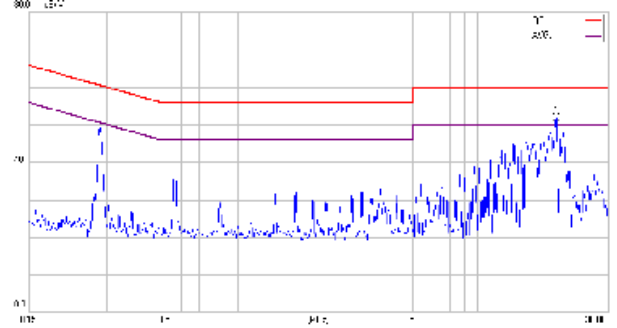

**Conducted Class B of CQB75W-24S24
Vin = 48Vdc**

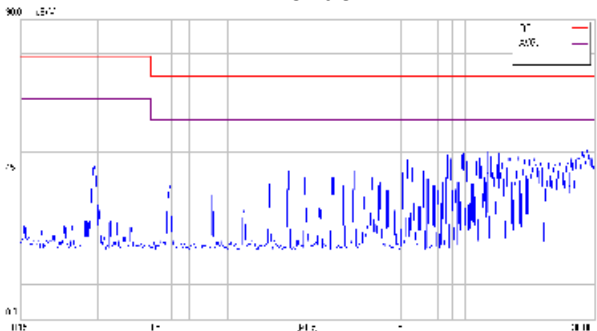

**Conducted Class A of CQB75W-48S33
Vin = 48Vdc**

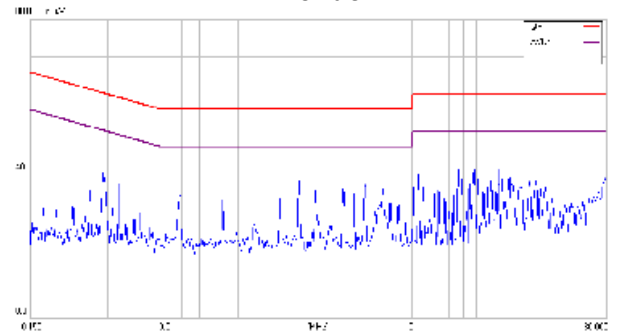

**Conducted Class B of CQB75W-48S33
Vin = 48Vdc**

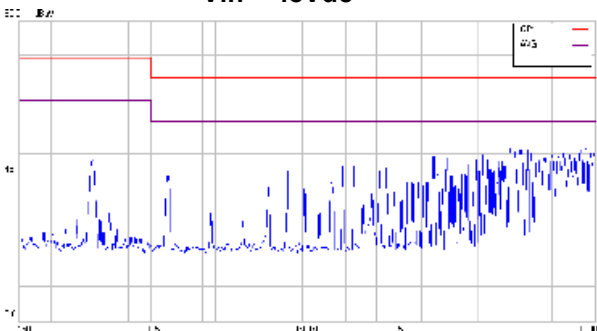

**Conducted Class A of CQB75W-48S05
Vin = 48Vdc**

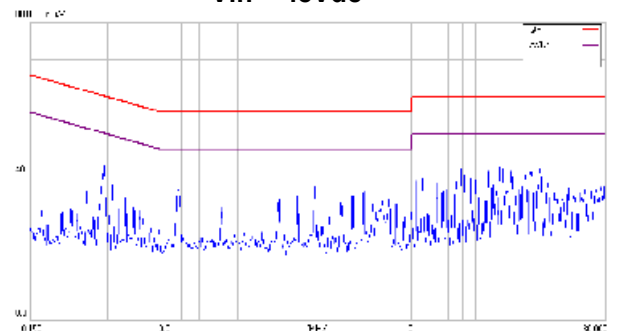

**Conducted Class B of CQB75W-48S05
Vin = 48Vdc**

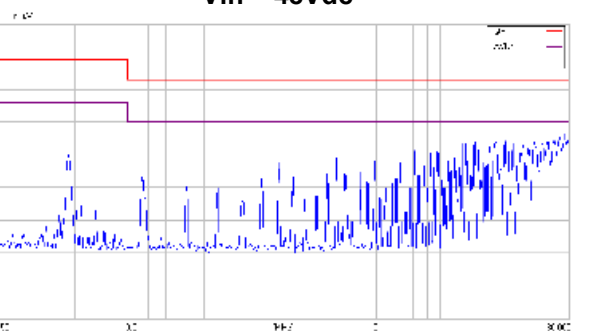

Conducted Class A of CQB75W-48S12

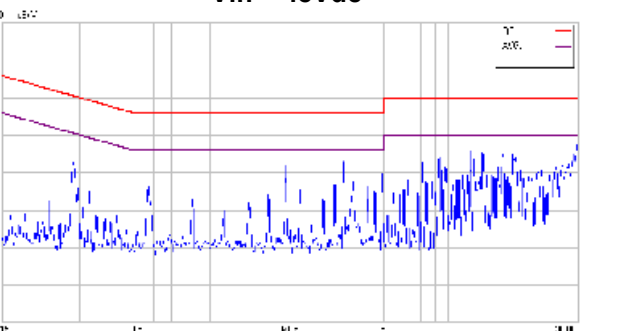

Conducted Class B of CQB75W-48S12



CQB75W Series

Application Note V12 February 2020

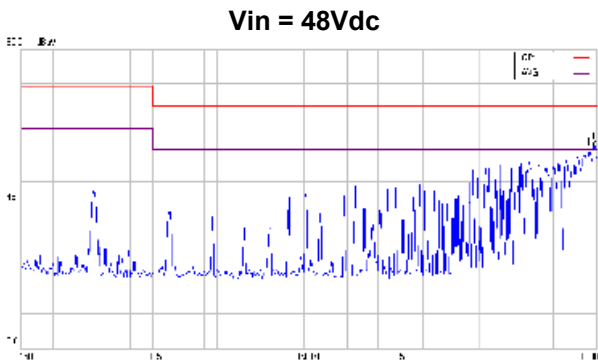

Conducted Class A of CQB75W-48S15
Vin = 48Vdc

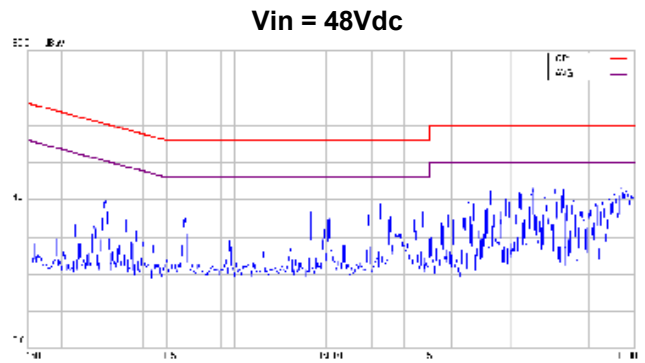

Conducted Class B of CQB75W-48S15
Vin = 48Vdc

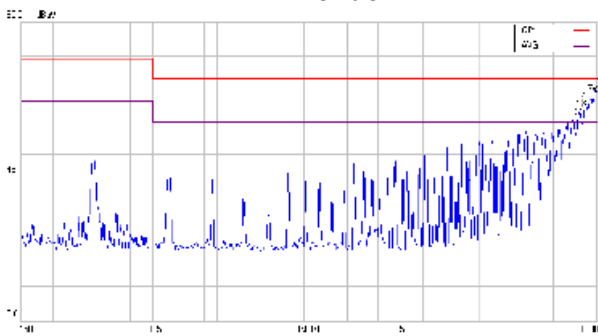

Conducted Class A of CQB75W-48S24

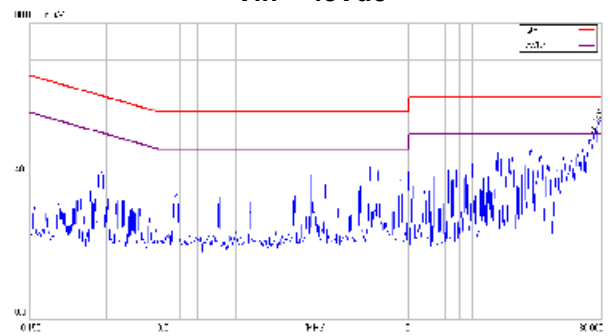

Conducted Class B of CQB75W-48S24



CQB75W Series

Application Note V12 February 2020

8. Part Number

Format: CQB75W - II X 00 L

Parameter	Series	Nominal Input Voltage	Number of Outputs	Output Voltage	Remote ON/OFF Logic
Symbol	CQB75W	II	X	00	L
Value	CQB75W	24: 24 Volts 48: 48 Volts	S: Single	3V3: 3.3 Volts 05: 05 Volts 12: 12 Volts 15: 15 Volts 24: 24 Volts	None: Positive N: Negative

9. Mechanical Specifications

9.1 Mechanical Outline Diagrams

All Dimensions In Inches(mm)
 Tolerances Inches: X.XX= ±0.02 , X.XXX= ±0.010
 Millimeters: X.X= ±0.5 , X.XX=±0.25

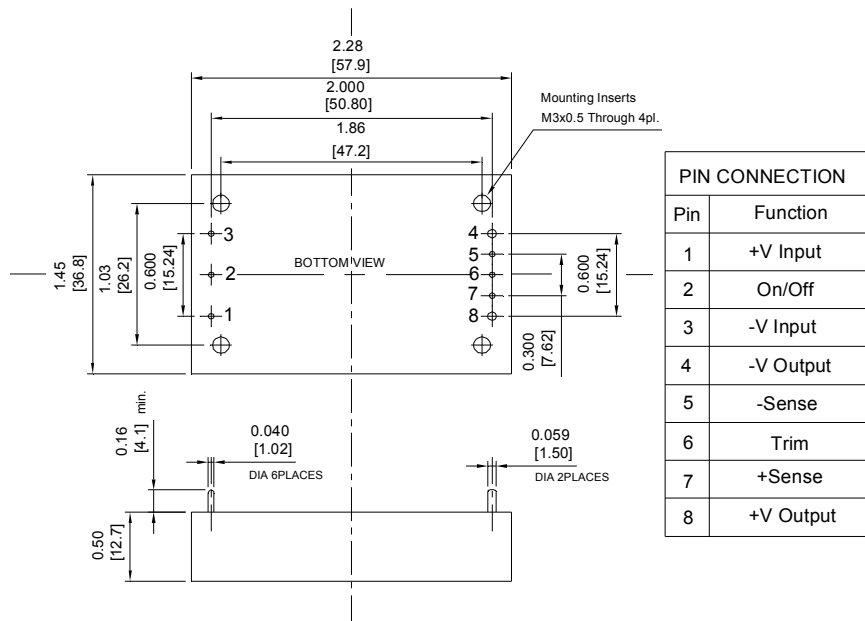

CQB75W Mechanical Outline Diagram

CINCON ELECTRONICS CO., LTD.

Headquarters:

14F, No.306, Sec.4, Hsin Yi Rd.
 Taipei, Taiwan
 Tel: 886-2-27086210
 Fax: 886-2-27029852
 E-mail: sales@cincon.com.tw
 Web Site: http://www.cincon.com

Factory:

No. 8-1, Fu Kung Rd.
 Fu Hsing Industrial Park
 Fu Hsing Hsiang,
 Chang Hua Hsien, Taiwan
 Tel: 886-4-7690261
 Fax: 886-4-7698031

Cincon North America:

1655 Mesa Verde Ave. Ste 180
 Ventura, CA 93003
 Tel: 805-639-3350
 Fax: 805-639-4101
 E-mail: info@cincon.com